



Downflow/Horizontal Right or Downflow/Horizontal Left Induced Draft Gas Furnace

XR 80

TDD1A040A9241A, TDD1A060A9241A, TDD1A060A9361A,
TDD1B060A9361A, TDD1B080A9361A, TDD1B080A9451A
TDD1B100A9451A, TDD1C100A9481A, TDD1C100A9541A
TDD1C120A9541A, TDD1D120A9601A, TDD1D140A9601A

Single-Stage Fan Assisted
Combustion System

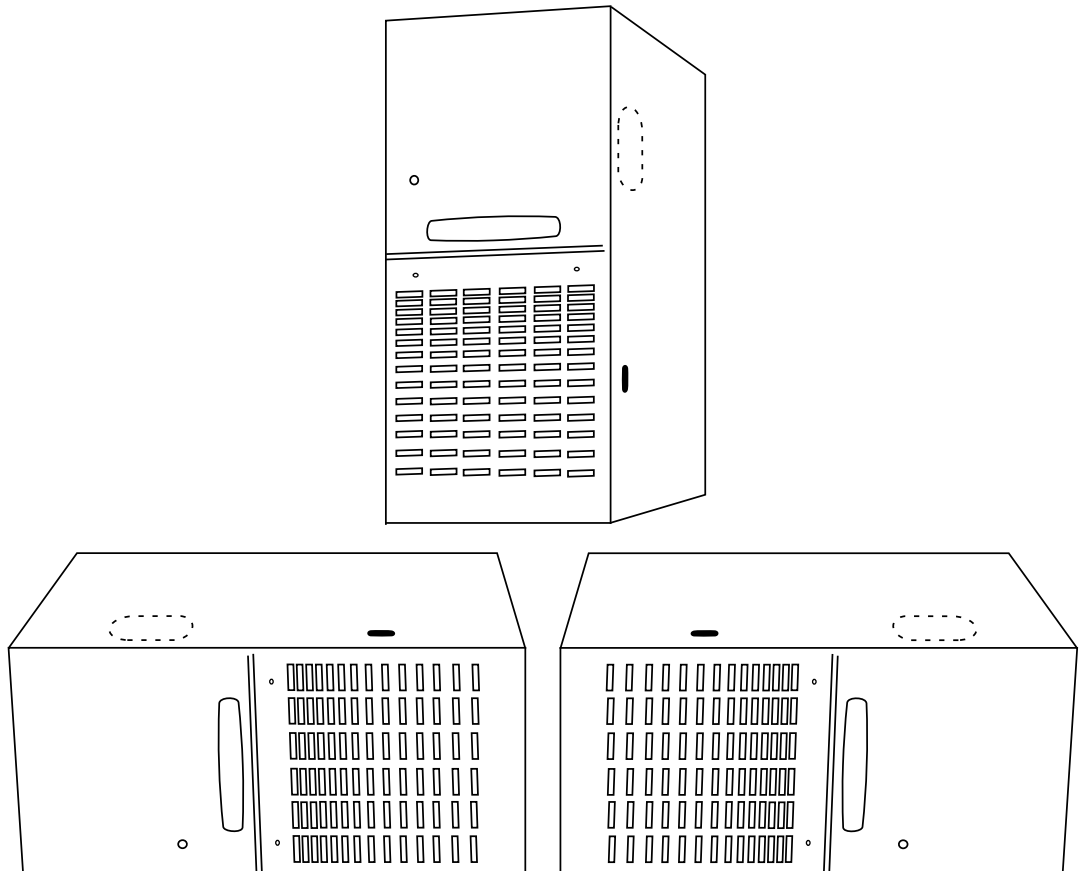

PUB. NO. 22-1671-10



General Features

Natural Gas Models

Central Heating furnace designs are certified by the American and Canadian Gas Associations for both natural and L.P. gas. Limit setting and rating data were established and approved under standard rating conditions using American National Standards Institute standards.

Safe Operation

The Integrated System Control has solid state devices, which continuously monitor for presence of flame, when the system is in the heating mode of operation. Dual solenoid combination gas valve and regulator provide extra safety.

Quick Heating

Durable, cycle tested, heavy gauge **aluminized steel heat exchanger** quickly transfers heat to provide warm conditioned air to the structure.

Burners

Multi-port In-shot burners will give years of quiet and efficient service. All models can be converted to **L.P. gas**.

Integrated System Control

Exclusively designed operational program provides total control of furnace limit sensors, blowers, gas valve, flame control and includes self-diagnostics for ease of service. Also contains connection points for E.A.C./humidifier.

Air Delivery

The 4-speed, direct drive blower motor, has sufficient airflow for most heating and cooling requirements, will switch from heating to cooling speeds on demand from room thermostat. The blower door safety switch will prevent or terminate furnace operation when the blower door is removed.

Styling

Heavy gauge steel and “wrap-around” cabinet construction is used in the cabinet with baked-on enamel finish for strength and beauty. The heat exchanger section of the cabinet is completely lined with foil faced fiberglass insulation. This results in quiet and efficient operation due to the excellent acoustical and insulating qualities of fiberglass.

Features and

General Operation

The XR 80 High Efficiency Gas Furnace employs an adaptive Hot Surface Ignition system, which eliminates the waste of a constant burning pilot. The integrated system control lights the main burners upon a demand for heat from the room thermostat. Complete front service access.

- a. Low energy power venter
- b. Vent proving pressure switch.

Contents

General Features	2
Features and Benefits	4
Standard Equipment	4
Optional Equipment	5
General Data	6
TDD1A040A9241A	6
TDD1A060A9241A	6
TDD1A060A9361A	6
TDD1B060A9361A	7
TDD1B080A9361A	7
TDD1B080A9451A	7
TDD1B100A9451A	8
TDD1C100A9481A	8
TDD1C100A9541A	8
TDD1C120A9541A	9
TDD1D120A9601A	9
TDD1D140A9601A	9
Performance Data	10
Electrical Data	12
Field Wiring	14
Dimensions	16



Features and Benefits

XR 80 Downflow/Horizontal Right or Left Standard Equipment

- Power supply 115/1/60
- Multi-port In-shot burners
- Integrated solid state control with self-diagnostics
- Silicon Nitride hot surface igniter with adaptive heat up
- Complete front service access
- Heavy gauge aluminized steel heat exchanger
- Slide out blower assembly
- Blower door safety switch
- Direct drive, 4-speed motor
- Optional L.P. conversion kit
- Common vent
- Left and right side knockout for venting
- Selectable cooling fan off delay eliminates need for BAY24X045 time delay relay
- Quiet slow opening gas valve
- Downflow convertible to horizontal on left or right side
- Insulated blower compartment
- Accessory hook-up capability – Hum and EAC
- Quiet induced draft blower
- Left/right gas connection
- 24 volt fuse
- Manual reset flame rollout switches



Features and Benefits

Optional Equipment

Thermostat	BAYSTAT388 []
Thermostat, Heating/Cooling Single Stage (Mounts Horizontally)	AY28X092 []
Thermostat, Heating/Cooling Single Stage (Mounts Vertically)	BAYSTAT305 []
Thermostat, Electronic Programmable 1-Stage Heating/1-Stage Cooling	TAYSTAT300C []
Propane Conversion Kit	BAYLPKT210A []
Electronic Air Filter, "Perfect Fit" High Efficiency (14-1/2" Wide Gas Furnace)	TFM145A9FR1 []
Electronic Air Filter, "Perfect Fit" High Efficiency (17-1/2" Wide Gas Furnace)	TFM175A9FR1 []
Electronic Air Filter, "Perfect Fit" High Efficiency (21" Wide Gas Furnace)	TFM210A9FR1 []
Electronic Air Filter, "Perfect Fit" High Efficiency (24-1/2" Wide Gas Furnace)	TFM245A9FR1 []
Electronic Air Filter, "Perfect Fit" Standard Efficiency (17-1/2" Wide Gas Furnace)	TFP175A9FR01 []
Electronic Air Filter, "Perfect Fit" Standard Efficiency (21" Wide Gas Furnace)	TFP210A9FR01 []
Electronic Air Filter, "Perfect Fit" Standard Efficiency (24-1/2" Wide Gas Furnace)	TFP245A9FR01 []
Coil Enclosure (14-1/2" Wide Cabinets)	BAYCLE14A1422A []
Coil Enclosure (17-1/2" Wide Cabinets)	BAYCLE17A1722A []
Coil Enclosure (21" Wide Cabinets)	BAYCLE21A2130A []
Coil Enclosure (24-1/2" Wide Cabinets)	BAYCLE24A2430A []
Filter Access Door Kit	BAYFLTR206 []
Downflow Subbase	BAYBASE205 []
High Altitude Pressure Switch Kit	BAYHALT248 []



General Data

Product Specifications ^①

MODEL	TDD1A040A9241A	TDD1A060A9241A	TDD1A060A9361A
TYPE	Downflow / Horizontal	Downflow / Horizontal	Downflow / Horizontal
RATINGS ^②			
Input BTUH	40,000	60,000	60,000
Capacity BTUH (ICS) ^③	31,000	48,000	48,000
AFUE	80.0	80.0	80.0
Temp. rise (Min.-Max.) °F.	30 - 60	35 - 65	30 - 60
BLOWER DRIVE	DIRECT	DIRECT	DIRECT
Diameter - Width (In.)	10 x 6	10 x 7	11 x 7
No. Used	1	1	1
Speeds (No.)	4	4	4
CFM vs. in. w.g.	See Fan Performance Table	See Fan Performance Table	See Fan Performance Table
Motor HP	1/5	1/5	1/2
R.P.M.	1075	1075	1075
Volts / Ph / Hz	115/1/60	115/1/60	115/1/60
COMBUSTION FAN - Type	Centrifugal	Centrifugal	Centrifugal
Drive - No. Speeds	Direct - 1	Direct - 1	Direct - 1
Motor HP - RPM	1/50 - 3000	1/50 - 3000	1/50 - 3000
Volts / Ph / Hz	115/1/60	115/1/60	115/1/60
FLA	1.0	1.0	1.0
FILTER — Furnished?	No	No	No
Type Recommended	High Velocity	High Velocity	High Velocity
Hi Vel. (No.-Size-Thk.)	2 - 14x20 - 1in.	2 - 14x20 - 1in.	2 - 14x20 - 1in.
VENT — Size (in.)	4 Round	4 Round	4 Round
HEAT EXCHANGER			
Type -Fired	Aluminized Steel - Type I	Aluminized Steel - Type I	Aluminized Steel - Type I
-Unfired			
Gauge (Fired)	20	20	20
ORIFICES — Main			
Nat. Gas. Qty. — Drill Size	2 — 45	3 — 45	3 — 45
L.P. Gas Qty. — Drill Size	2 — 56	3 — 56	3 — 56
GAS VALVE	Redundant - Single Stage	Redundant - Single Stage	Redundant - Single Stage
PILOT SAFETY DEVICE			
Type	Hot Surface Ignition	Hot Surface Ignition	Hot Surface Ignition
BURNERS — Type	Multi-port In-shot	Multi-port In-shot	Multi-port In-shot
Number	2	3	3
POWER CONN. — V / Ph / Hz ^④	115/1/60	115/1/60	115/1/60
Ampacity (In Amps)	5.4	5.5	11.6
Max. Overcurrent Protection (Amps)	15	15	15
PIPE CONN. SIZE (IN.)	1/2	1/2	1/2
DIMENSIONS	H x W x D	H x W x D	H x W x D
Crated (In.)	41 x 15-1/2 x 29-1/2	41 x 15-1/2 x 29-1/2	41 x 15-1/2 x 29-1/2
WEIGHT			
Shipping (Lbs.) / Net (Lbs)	119 / 109	129 / 119	129 / 119

① Central Furnace heating designs are certified by AGA and CSA.

② For U.S. applications, above input ratings (BTUH) are up to 2,000 ft., derate 4% per 1,000 ft. for elevations above 2,000 ft. above sea level.
For Canadian applications, above input ratings (BTUH) are up to 4,500 ft., derate 4% per 1,000 ft. for elevations above 4,500 ft. above sea level.

③ Based on U.S. government standard tests.

④ The above wiring specifications are in accordance with National Electrical Code; however, installations must comply with local codes.



General Data

Product Specifications ^①

MODEL	TDD1B060A9361A	TDD1B080A9361A	TDD1B080A9451A
TYPE	Downflow / Horizontal	Downflow / Horizontal	Downflow / Horizontal
RATINGS ^②			
Input BTUH	60,000	80,000	80,000
Capacity BTUH (ICS) ^③	48,000	64,000	64,000
AFUE	80.0	80.0	80.0
Temp. rise (Min.-Max.) °F.	30 - 60	35 - 65	35 - 65
BLOWER DRIVE	DIRECT	DIRECT	DIRECT
Diameter - Width (In.)	10 x 7	10 x 7	10 x 8
No. Used	1	1	1
Speeds (No.)	4	4	4
CFM vs. in. w.g.	See Fan Performance Table	See Fan Performance Table	See Fan Performance Table
Motor HP	1/3	1/3	1/3
R.P.M.	1075	1075	1075
Volts / Ph / Hz	115/1/60	115/1/60	115/1/60
COMBUSTION FAN - Type	Centrifugal	Centrifugal	Centrifugal
Drive - No. Speeds	Direct - 1	Direct - 1	Direct - 1
Motor HP - RPM	1/50 - 3000	1/50 - 3000	1/50 - 3000
Volts / Ph / Hz	115/1/60	115/1/60	115/1/60
FLA	1.0	1.0	1.0
FILTER — Furnished?	No	No	No
Type Recommended	High Velocity	High Velocity	High Velocity
Hi Vel. (No.-Size-Thk.)	2 - 14x20 - 1in.	2 - 14x20 - 1in.	2 - 16x20 - 1in.
VENT — Size (in.)	4 Round	4 Round	4 Round
HEAT EXCHANGER			
Type -Fired	Aluminized Steel - Type I	Aluminized Steel - Type I	Aluminized Steel - Type I
-Unfired			
Gauge (Fired)	20	20	20
ORIFICES — Main			
Nat. Gas. Qty. — Drill Size	3 — 45	4 — 45	4 — 45
L.P. Gas Qty. — Drill Size	3 — 56	4 — 56	4 — 56
GAS VALVE	Redundant - Single Stage	Redundant - Single Stage	Redundant - Single Stage
PILOT SAFETY DEVICE			
Type	Hot Surface Ignition	Hot Surface Ignition	Hot Surface Ignition
BURNERS — Type	Multi-port In-shot	Multi-port In-shot	Multi-port In-shot
Number	3	4	4
POWER CONN. — V / Ph / Hz ^④	115/1/60	115/1/60	115/1/60
Ampacity (In Amps)	11.6	9.0	9.8
Max. Overcurrent Protection (Amps)	15	15	15
PIPE CONN. SIZE (IN.)	1/2	1/2	1/2
DIMENSIONS	H x W x D	H x W x D	H x W x D
Crated (In.)	41 x 18-1/2 x 29-1/2	41 x 18-1/2 x 29-1/2	41 x 18-1/2 x 29-1/2
WEIGHT			
Shipping (Lbs.) / Net (Lbs)	134 / 124	146 / 135	146 / 135

① Central Furnace heating designs are certified by AGA and CSA.

② For U.S. applications, above input ratings (BTUH) are up to 2,000 ft., derate 4% per 1,000 ft. for elevations above 2,000 ft. above sea level.
For Canadian applications, above input ratings (BTUH) are up to 4,500 ft., derate 4% per 1,000 ft. for elevations above 4,500 ft. above sea level.

③ Based on U.S. government standard tests.

④ The above wiring specifications are in accordance with National Electrical Code; however, installations must comply with local codes.



General Data

Product Specifications ^①

MODEL	TDD1B100A9451A	TDD1C100A9481A	TDD1C100A9541A
TYPE	Downflow / Horizontal	Downflow / Horizontal	Downflow / Horizontal
RATINGS ^②			
Input BTUH	100,000	100,000	100,000
Capacity BTUH (ICS) ^③	80,000	80,000	81,000
AFUE	80.0	80.0	80.0
Temp. rise (Min.-Max.) °F.	35 - 65	35 - 65	30 - 60
BLOWER DRIVE	DIRECT	DIRECT	DIRECT
Diameter - Width (In.)	10 x 8	10 x 8	11 x 10
No. Used	1	1	1
Speeds (No.)	4	4	4
CFM vs. in. w.g.	See Fan Performance Table	See Fan Performance Table	See Fan Performance Table
Motor HP	1/3	1/2	1/2
R.P.M.	1075	1075	1075
Volts / Ph / Hz	115/1/60	115/1/60	115/1/60
COMBUSTION FAN - Type	Centrifugal	Centrifugal	Centrifugal
Drive - No. Speeds	Direct - 1	Direct - 1	Direct - 1
Motor HP - RPM	1/50 - 3200	1/50 - 3000	1/50 - 3000
Volts / Ph / Hz	115/1/60	115/1/60	115/1/60
FLA	1.0	1.0	1.0
FILTER — Furnished?	No	No	No
Type Recommended	High Velocity	High Velocity	High Velocity
Hi Vel. (No.-Size-Thk.)	2 - 16x20 - 1in.	2 - 16x20 - 1in.	2 - 14x20 - 1in.
VENT — Size (in.)	4 Round	4 Round	4 Round
HEAT EXCHANGER			
Type -Fired	Aluminized Steel - Type I	Aluminized Steel - Type I	Aluminized Steel - Type I
-Unfired			
Gauge (Fired)	20	20	20
ORIFICES — Main			
Nat. Gas. Qty. — Drill Size	5 — 45	5 — 45	5 — 45
L.P. Gas Qty. — Drill Size	5 — 56	5 — 56	5 — 56
GAS VALVE	Redundant - Single Stage	Redundant - Single Stage	Redundant - Single Stage
PILOT SAFETY DEVICE			
Type	Hot Surface Ignition	Hot Surface Ignition	Hot Surface Ignition
BURNERS — Type	Multi-port In-shot	Multi-port In-shot	Multi-port In-shot
Number	5	5	5
POWER CONN. — V / Ph / Hz ^④	115/1/60	115/1/60	115/1/60
Ampacity (In Amps)	9.8	11.6	13.4
Max. Overcurrent Protection (Amps)	15	15	20
PIPE CONN. SIZE (IN.)	1/2	1/2	1/2
DIMENSIONS	H x W x D	H x W x D	H x W x D
Crated (In.)	41 x 18-1/2 x 29-1/2	41 x 22 x 29-1/2	41 x 22 x 29-1/2
WEIGHT			
Shipping (Lbs.) / Net (Lbs)	156 / 145	166 / 154	167 / 155

① Central Furnace heating designs are certified by AGA and CSA.

② For U.S. applications, above input ratings (BTUH) are up to 2,000 ft., derate 4% per 1,000 ft. for elevations above 2,000 ft. above sea level.
For Canadian applications, above input ratings (BTUH) are up to 4,500 ft., derate 4% per 1,000 ft. for elevations above 4,500 ft. above sea level.

③ Based on U.S. government standard tests.

④ The above wiring specifications are in accordance with National Electrical Code; however, installations must comply with local codes.



General Data

Product Specifications ^①

MODEL	TDD1C120A9541A	TDD1D120A9601A	TDD1D140A9601A
TYPE	Downflow / Horizontal	Downflow / Horizontal	Downflow / Horizontal
RATINGS ^②			
Input BTUH	120,000	120,000	140,000
Capacity BTUH (ICS) ^③	96,000	96,000	113,000
AFUE	80.0	80.0	80.0
Temp. rise (Min.-Max.) °F.	35 - 65	35 - 65	45 - 75
BLOWER DRIVE	DIRECT	DIRECT	DIRECT
Diameter - Width (In.)	11 x 10	11 x 10	11 x 10
No. Used	1	1	1
Speeds (No.)	4	4	4
CFM vs. in. w.g.	See Fan Performance Table	See Fan Performance Table	See Fan Performance Table
Motor HP	1/2	1/2	3/4
R.P.M.	1075	1075	1075
Volts / Ph / Hz	115/1/60	115/1/60	115/1/60
COMBUSTION FAN - Type	Centrifugal	Centrifugal	Centrifugal
Drive - No. Speeds	Direct - 1	Direct - 1	Direct - 1
Motor HP - RPM	1/50 - 3000	1/50 - 3000	1/50 - 3000
Volts / Ph / Hz	115/1/60	115/1/60	115/1/60
FLA	1.0	1.0	1.0
FILTER — Furnished?	No	No	No
Type Recommended	High Velocity	High Velocity	High Velocity
Hi Vel. (No.-Size-Thk.)	2 - 16x20 - 1in.	2 - 16x20 - 1in.	2 - 16x20 - 1in.
VENT — Size (in.)	4 Round	4 Round	4 Round
HEAT EXCHANGER			
Type -Fired	Aluminized Steel - Type I	Aluminized Steel - Type I	Aluminized Steel - Type I
-Unfired			
Gauge (Fired)	20	20	20
ORIFICES — Main			
Nat. Gas. Qty. — Drill Size	6 — 45	6 — 45	7 — 45
L.P. Gas Qty. — Drill Size	6 — 56	6 — 56	7 — 56
GAS VALVE	Redundant - Single Stage	Redundant - Single Stage	Redundant - Single Stage
PILOT SAFETY DEVICE			
Type	Hot Surface Ignition	Hot Surface Ignition	Hot Surface Ignition
BURNERS — Type	Multi-port In-shot	Multi-port In-shot	Multi-port In-shot
Number	6	6	7
POWER CONN. — V / Ph / Hz ^④	115/1/60	115/1/60	115/1/60
Ampacity (In Amps)	13.4	13.4	13.8
Max. Overcurrent Protection (Amps)	20	20	20
PIPE CONN. SIZE (IN.)	1/2	1/2	1/2
DIMENSIONS	H x W x D	H x W x D	H x W x D
Crated (In.)	41 x 22 x 29-1/2	41 x 25-1/2 x 29-1/2	41 x 25_-1/2 x 28
WEIGHT			
Shipping (Lbs.) / Net (Lbs)	170 / 158	189 / 176	196 / 183

① Central Furnace heating designs are certified by AGA and CSA.

② For U.S. applications, above input ratings (BTUH) are up to 2,000 ft., derate 4% per 1,000 ft. for elevations above 2,000 ft. above sea level.
For Canadian applications, above input ratings (BTUH) are up to 4,500 ft., derate 4% per 1,000 ft. for elevations above 4,500 ft. above sea level.

③ Based on U.S. government standard tests.

④ The above wiring specifications are in accordance with National Electrical Code; however, installations must comply with local codes.



Performance Data

FURNACE AIRFLOW (CFM) VS. STATIC PRESSURE (ins. w.g.)										
MODEL	SPEED TAP	0.10	0.20	0.30	0.40	0.50	0.60	0.70	0.80	0.90
*DD1A040A9241A	4 - HIGH - Black	1070	1033	1000	960	920	860	810	740	-
	3 - MED - HIGH - Blue	870	850	823	790	753	813	667	613	490
	2 - MED - LOW - Yellow	740	720	690	663	627	588	547	483	-
	1 - LOW - Red	633	600	577	543	507	463	420	360	-
*DD1A060A9241A	4 - HIGH - Black	1200	1155	1111	1056	1001	924	848	774	701
	3 - MED - HIGH - Blue	1025	988	951	905	859	797	735	646	558
	2 - MED - LOW - Yellow	838	808	779	742	704	646	588	502	415
	1 - LOW - Red	722	689	656	618	579	528	478	376	275
*DD1A060A9361A	4 - HIGH - Black	1480	1429	1375	1318	1282	1100	1112	1029	959
	3 - MED - HIGH - Blue	1302	1276	1229	1188	1141	1088	1024	953	882
*DD1B060A9361A	2 - MED - LOW - Yellow	1115	1100	1070	1035	1000	965	918	859	790
	1 - LOW - Red	956	947	918	888	859	824	788	741	682
*DD1B080A9361A	4 - HIGH - Black	1523	1496	1463	1420	1369	1310	1243	1172	1100
	3 - MED - HIGH - Blue	1317	1307	1261	1242	1223	1175	1122	1060	1000
	2 - MED - LOW - Yellow	1123	1119	1106	1082	1056	1016	976	930	880
	1 - LOW - Red	942	943	931	920	898	868	833	795	760
*DD1B080A9451A	4 - HIGH - Black	1798	1750	1692	1642	1575	1500	1425	1325	1225
	3 - MED - HIGH - Blue	1384	1367	1333	1300	1275	1233	1192	1142	1083
	2 - MED - LOW - Yellow	1210	1150	1108	1075	1042	1008	967	925	867
	1 - LOW - Red	1005	970	808	775	767	733	700	675	617
*DD1B100A9451A	4 - HIGH - Black	1767	1731	1669	1615	1546	1469	1392	1300	1146
	3 - MED - HIGH - Blue	1382	1354	1323	1292	1254	1207	1177	1108	1038
	2 - MED - LOW - Yellow	1130	1138	1115	1085	1054	1015	977	938	877
	1 - LOW - Red	840	831	815	792	762	731	700	654	625
*DD1C100A9481A	4 - HIGH - Black	1965	1915	1865	1805	1740	1670	1587	1500	1370
	3 - MED - HIGH - Blue	1645	1627	1605	1575	1535	1482	1421	1330	1220
	2 - MED - LOW - Yellow	1407	1398	1387	1375	1347	1318	1275	1190	1095
	1 - LOW - Red	1202	1208	1205	1195	1166	1140	1105	1045	970
*DD1B100A9541A	4 - HIGH - Black	2165	2113	2060	1995	1929	1842	1755	1674	1593
	3 - MED - HIGH - Blue	1962	1927	1891	1839	1786	1724	1662	1581	1500
	2 - MED - LOW - Yellow	1705	1688	1671	1636	1600	1547	1492	1435	1377
	1 - LOW - Red	1492	1467	1442	1414	1385	1346	1307	1243	1179
*DD1C120A9541A	4 - HIGH - Black	2100	2049	1997	1958	1918	1852	1785	1695	1604
	3 - MED - HIGH - Blue	1917	1887	1857	1842	1827	1751	1674	1594	1514
	2 - MED - LOW - Yellow	1672	1656	1639	1631	1623	1560	1496	1427	1358
	1 - LOW - Red	1485	1478	1470	1448	1426	1388	1349	1278	1207
*DD1D120A9601A	4 - HIGH - Black	2241	2202	2163	2106	2049	1979	1908	1804	1700
	3 - MED - HIGH - Blue	1981	1962	1942	1904	1866	1805	1743	1680	1617
	2 - MED - LOW - Yellow	1721	1705	1688	1671	1653	1611	1569	1515	1461
	1 - LOW - Red	1476	1466	1456	1440	1423	1392	1361	1302	1243
*DD1D140A9601A	4 - HIGH - Black	2377	2321	2265	2199	2133	2050	1967	1877	1786
	3 - MED - HIGH - Blue	2115	2081	2046	1992	1938	1872	1805	1727	1649
	2 - MED - LOW - Yellow	1806	1793	1779	1738	1696	1655	1614	1556	1497
	1 - LOW - Red	1527	1507	1486	1473	1459	1422	1384	1329	1273

* May be "A" or "T"



Performance Data

CFM VS. TEMPERATURE RISE																				
MODEL	Cubic Feet Per Minute (CFM)																			
	500	600	700	800	900	1000	1100	1200	1300	1400	1500	1600	1700	1800	1900	2000	2100	2200	2300	2400
TDD1A040A9241A	59	49	42	37	33	30														
TDD1A060A9241A			63	56	49	44	40													
TDD1A060A9361A				56	49	44	40	37	34	32										
TDD1B060A9361A				56	49	44	40	37	34	32										
TDD1B080A9361A						59	54	59	46	42										
TDD1B080A9451A					64	57	52	48	44	41										
TDD1B100A9451A								62	57	53	49	46	44	41						
TDD1C100A9481A								62	57	53	49	46	44	41	39	37				
TDD1C100A9451A								62	57	53	49	46	44	41	39	37	35	34	32	31
TDD1C120A9541A											59	56	52	49	47	44	42	40		
TDD1D120A9601A											59	56	52	49	47	44	42	40		
TDD1D140A9601A											69	65	61	58	55	52	49	47	45	

WIRING DIAGRAM

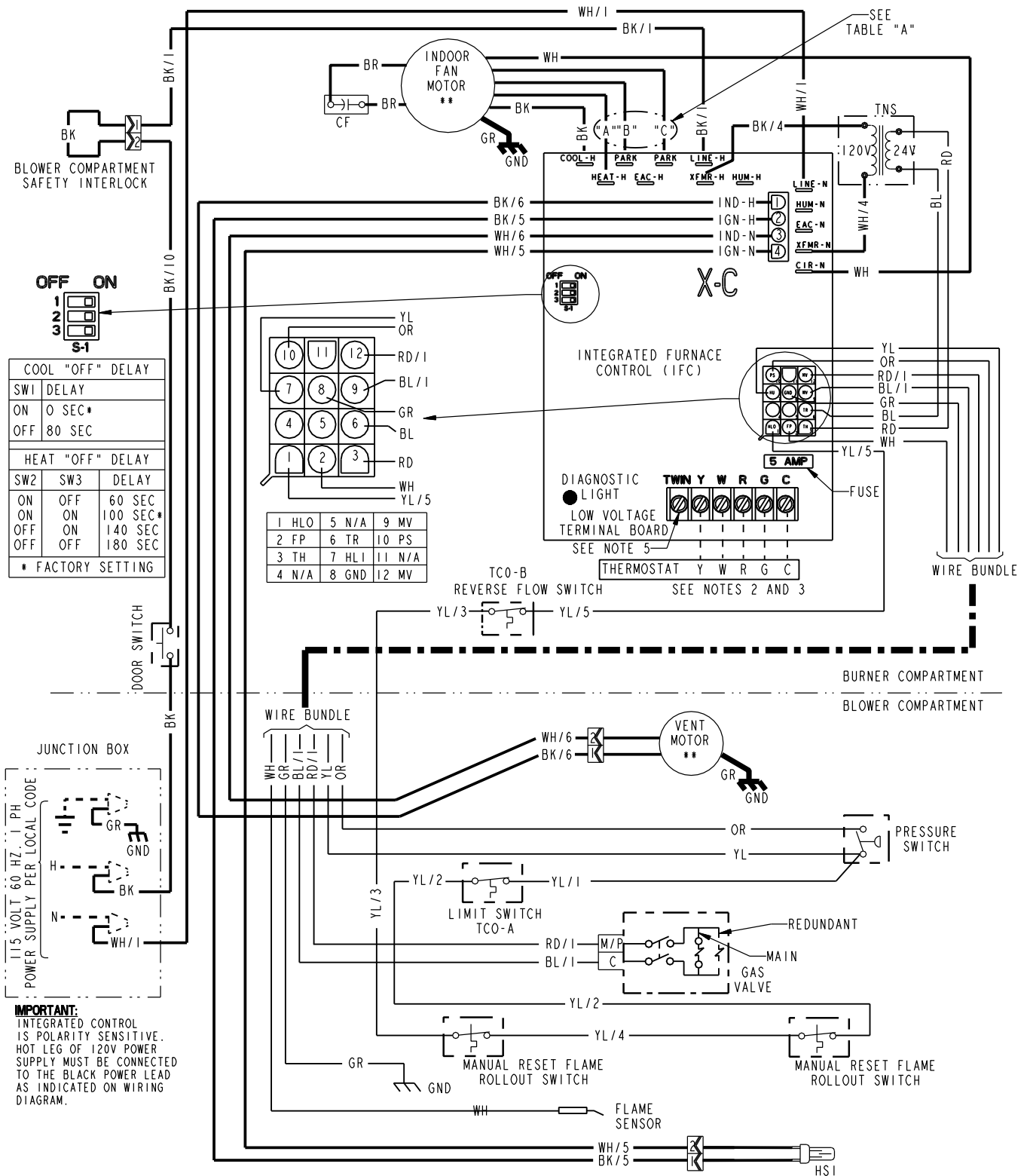

(continued on next page)

From Dwg. D342568P01 Rev. 1

SCHEMATIC DIAGRAM

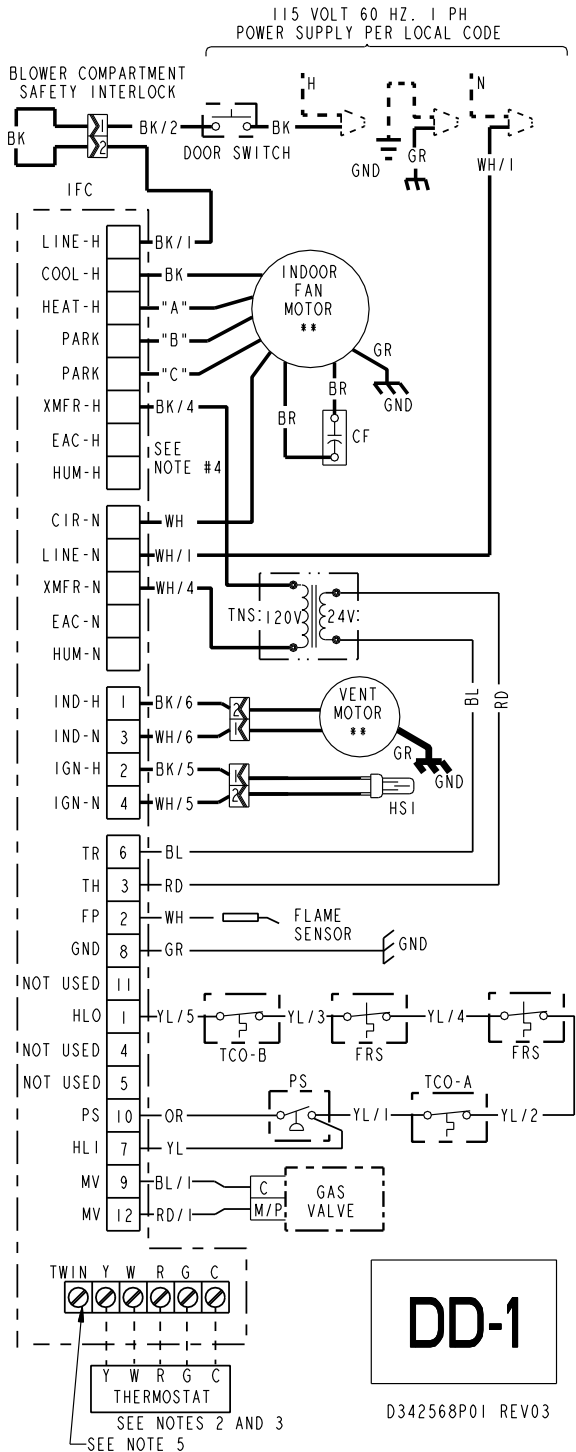

TABLE "A"
SPEED TAPS FOR I. D. FAN MOTOR

MODEL	HEAT "A"	PARK "B"	PARK "C"
*DDIA040A9241##	YL	RD	BL
*DDIA060A9241##	BL	RD	YL
*DDIA060A9361##	YL	RD	BL
*DDIB060A9361##	RD	BL	YL
*DDIB080A9361##	BL	RD	YL
*DDIB080A9451##	BL	RD	YL
*DDIB100A9451##	BL	RD	YL
*DDIC100A9481##	BL	RD	YL
*DDIC100A9541##	YL	RD	BL
*DDIC120A9541##	BL	RD	YL
*DDIDI20A9601##	BL	RD	YL
*DDIDI40A9601##	BL	RD	YL

* PREFIX MAY BE "A" OR "T"
SUFFIX MAY BE "A" THROUGH "Z"

RD = LOW BL = MED. HIGH
YL = MED. LOW BK = HIGH

WARNING

HAZARDOUS VOLTAGE:
DISCONNECT ALL ELECTRICAL POWER INCLUDING REMOTE DISCONNECTS BEFORE SERVICING.
FAILURE TO DISCONNECT POWER BEFORE SERVICING CAN CAUSE SEVERE PERSONAL INJURY OR DEATH.

CAUTION

USE COPPER CONDUCTORS ONLY!
UNIT TERMINALS ARE NOT DESIGNED TO ACCEPT OTHER TYPES OF CONDUCTORS.
FAILURE TO DO SO MAY CAUSE DAMAGE TO THE EQUIPMENT.

INTEGRATED FURNACE CONTROL

REPLACE WITH PART CNT03076 OR EQUIVALENT
INPUT: 25 VAC, 60 HZ.
XFMR SEC. CURRENT: 450 MA.
MV OUTPUT: 1.5 A @ 24 VAC
IND OUTPUT: 2.2 FLA, 3.5 LRA @ 120 VAC
CIRC. BLOWER OUTPUT: 14.5 FLA, 26 LRA @ 120 VAC
HUMIDIFIER & AIR CLEANER
MAX. LOAD: 1.0 A @ 120 VAC
IGNITER OUTPUT: 2.0 A @ 120 VAC

- DIAGNOSTIC CODES**
- | | |
|--|--|
| FLASHING SLOW: NORMAL - NO CALL FOR HEAT | 5 FLASHES: FLAME SENSED WHEN NO FLAME SHOULD BE PRESENT |
| FLASHING FAST: NORMAL - CALL FOR HEAT | |
| CONTINUOUS ON: REPLACE IFC | 6 FLASHES: 115 VAC POWER REVERSED POLARITY OR POOR GROUNDING |
| CONTINUOUS OFF: CHECK POWER | 7 FLASHES: GAS VALVE CIRCUIT ERROR |
| 2 FLASHES: EXTERNAL LOCKOUT (RETRIES OR RECYCLES EXCEEDED) | 8 FLASHES: LOW FLAME SENSE SIGNAL |
| 3 FLASHES: PRESSURE SWITCH ERROR | 9 FLASHES: CHECK IGNITER |
| 4 FLASHES: OPEN LIMIT DEVICE | |

TCO THERMAL CUT OUT	LINE } FACTORY WIRING	LINE } FIELD WIRING
PS PRESSURE SWITCH	24 V	24 V
FRS FLAME ROLLOUT SWITCH	** INTERNAL THERMAL PROTECTION	
FP FLAME SENSOR	CF CAPACITOR	
CHASSIS GROUND	COIL	
HSI HOT SURFACE IGNITER		
DOOR SWITCH		

BK	BLACK	GR	GREEN
WH	WHITE	BR	BROWN
YL	YELLOW	RD	RED
OR	ORANGE	BL	BLUE

BK/1 WIRE COLOR NUMBER ID (IF ANY)

L	LINE	TH	24 VAC (HOT)
N	NEUTRAL	TR	24 VAC (COMMON)
GND	GROUND	MV	MAIN GAS VALVE
B/C	COMMON	TNS	TRANSFORMER
HLO	HIGH LIMIT OUTPUT		
HLI	HIGH LIMIT INPUT		

- NOTES:**
- IF ANY OF THE ORIGINAL WIRING AS SUPPLIED WITH THIS FURNACE MUST BE REPLACED, IT MUST BE WITH WIRE HAVING A TEMPERATURE RATING OF AT LEAST 105 C.
 - THERMOSTAT HEAT ANTICIPATOR SETTING: .38 AMPS
 - FOR PROPER OPERATION OF COOLING SPEED, "Y" TERMINAL MUST BE CONNECTED TO THE ROOM THERMOSTAT.
 - THESE TERMINALS PROVIDE 120V POWER CONNECTIONS FOR ELECTRONIC AIR CLEANER (EAC) AND HUMIDIFIER (HUM). MAX. LOAD: 1.0 AMPS EACH.
 - WHEN TWINNING TWO FURNACES, BOTH UNITS MUST BE CONNECTED TO THE SAME 115 VAC PHASE CONNECT THE TWO UNITS 'TWIN' TERMINALS WITH 14 TO 22 AWG. WIRE.

DD-1

D342568P01 REV03

Field Wiring

FIELD WIRING DIAGRAM FOR SINGLE STAGE HEATING ONLY

NOTES

1. BE SURE POWER SUPPLY AGREES WITH EQUIPMENT NAMEPLATE(S).
2. LOW VOLTAGE (24V.) WIRING TO BE NO. 18 A.W.G. MIN.
3. GROUNDING OF EQUIPMENT MUST COMPLY WITH LOCAL CODES.
4. SET THERMOSTAT HEAT ANTICIPATOR PER UNIT WIRING DIAGRAM.
5. 24V COMMON CONNECTION MAY BE REQUIRED FOR USE WITH ELECTRONIC THERMOSTATS.

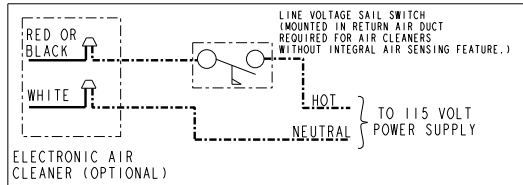
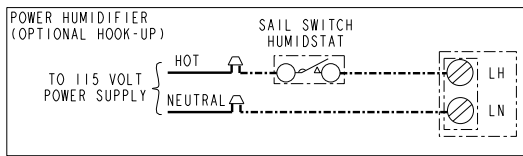

INTER-COMPONENT WIRING

----- 24 V. } FIELD WIRING
 - - - - - LINE V. }
 _____ 24 V. } FACTORY WIRING
 _____ LINE V. }

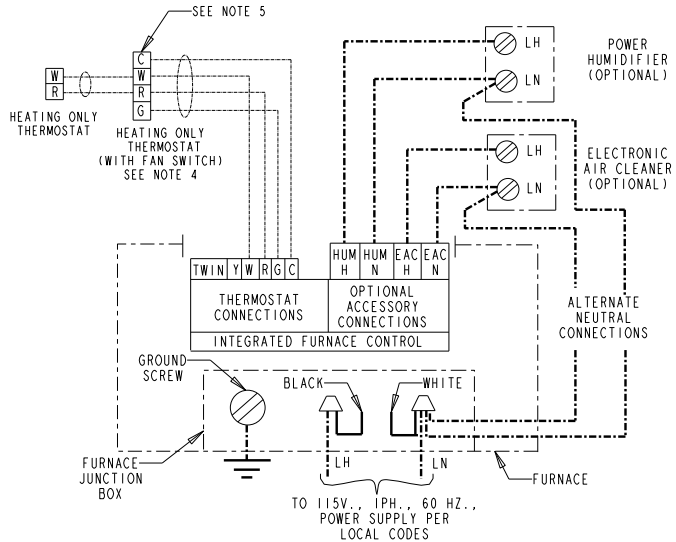

From Dwg. 21B341437 Rev. 1

FIELD WIRING DIAGRAM FOR SINGLE STAGE HEATING/COOLING (OUTDOOR SECTION WITHOUT TRANSFORMER)

NOTES

1. BE SURE POWER SUPPLY AGREES WITH EQUIPMENT NAMEPLATE(S).
2. LOW VOLTAGE (24V.) WIRING TO BE NO. 18 A.W.G. MIN.
3. GROUNDING OF EQUIPMENT MUST COMPLY WITH LOCAL CODES.
4. SET THERMOSTAT HEAT ANTICIPATOR PER UNIT WIRING DIAGRAM.
5. THE "Y" TERMINAL FROM THE THERMOSTAT MUST BE WIRED TO THE "Y" TERMINAL OF THE FURNACE CONTROL FOR PROPER BLOWER OPERATION DURING COOLING.
6. 24V COMMON CONNECTION MAY BE REQUIRED FOR USE WITH ELECTRONIC THERMOSTATS.

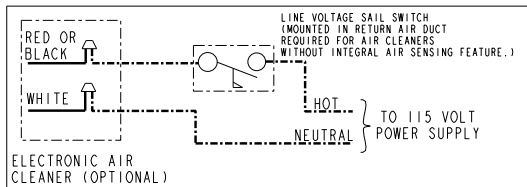
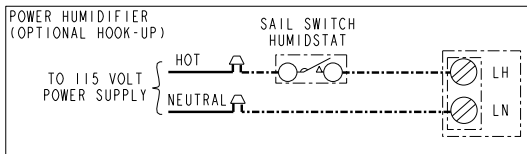

INTER-COMPONENT WIRING

----- 24 V. } FIELD WIRING
 - - - - - LINE V. }
 _____ 24 V. } FACTORY WIRING
 _____ LINE V. }

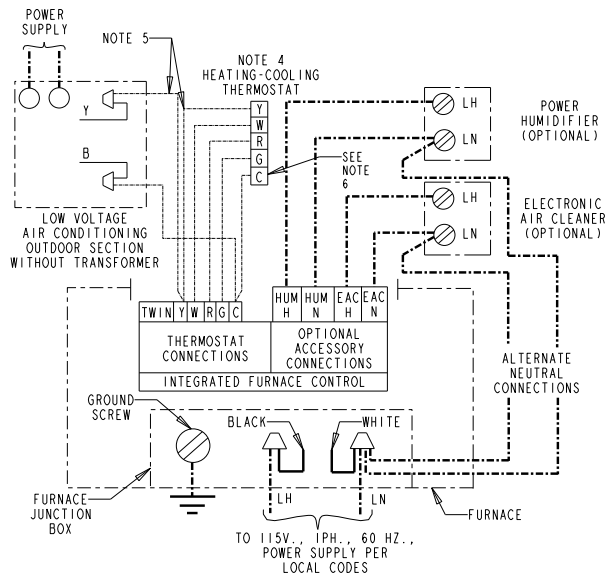

From Dwg. 21B341436 Rev. 1

Field Wiring

TWINNING CONNECTION DIAGRAM FOR TWINNING 1 STAGE FURNACES WITH SINGLE WIRE TWINNING FEATURE 1 STAGE HEATING ONLY THERMOSTAT

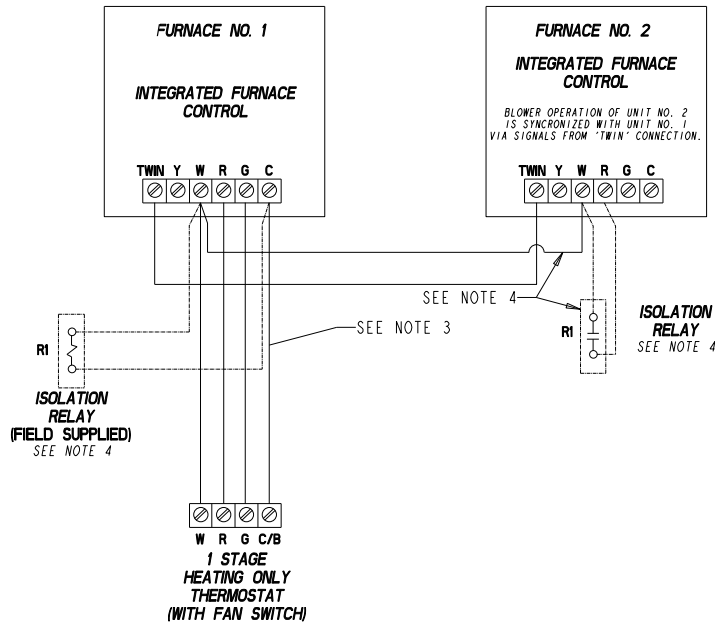

NOTES:

- 1.) BOTH FURNACES MUST BE POWERED FROM THE SAME 115V. LEG OF CIRCUIT PANEL.
- 2.) INSURE 24V. FURNACE TRANSFORMERS ARE IN PHASE. PRIOR TO COMPLETING CONNECTIONS, CHECK VOLTAGE BETWEEN 'R' TERMINALS OF EACH FURNACE. IF VOLTAGE IS GREATER THAN 10V., REVERSE THE BL AND RD SECONDARY LEADS ON ONE OF THE FURNACE TRANSFORMERS.
- 3.) CONNECTION MAY BE REQUIRED FOR ELECTRONIC THERMOSTAT.
- 4.) IF CURRENT EXCEEDS THERMOSTAT CURRENT RATING, USE ISOLATION RELAYS ('RI') AS SHOWN. (DO NOT CONNECT W TO W) ISOLATION RELAY NOT NEEDED IF THE THERMOSTAT CONTACTS ARE RATED AT 1.0A. OR ABOVE.

----- ALTERNATE WIRING CONFIGURATION SEE NOTE 4.

From Dwg. 21B341422 Rev. 1

TWINNING CONNECTION DIAGRAM FOR TWINNING 1 STAGE FURNACES WITH SINGLE WIRE TWINNING FEATURE 1 STAGE HEAT / 1 STAGE COOLING THERMOSTAT

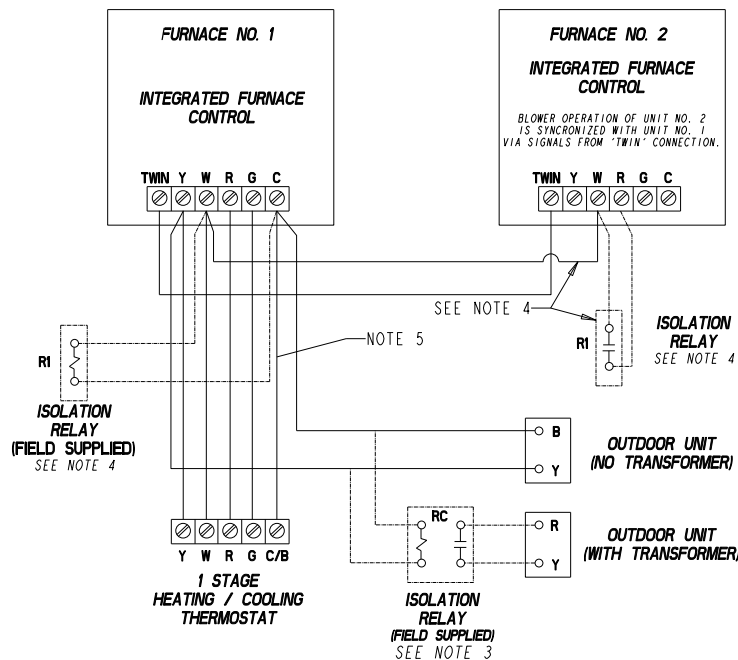

NOTES:

- 1.) BOTH FURNACES MUST BE POWERED FROM THE SAME 115V. LEG OF CIRCUIT PANEL.
- 2.) INSURE 24V. FURNACE TRANSFORMERS ARE IN PHASE. PRIOR TO COMPLETING CONNECTIONS, CHECK VOLTAGE BETWEEN 'R' TERMINALS OF EACH FURNACE. IF VOLTAGE IS GREATER THAN 10V., REVERSE THE BL AND RD SECONDARY LEADS ON ONE OF THE FURNACE TRANSFORMERS.
- 3.) IF OUTDOOR UNIT HAS A 24V. TRANSFORMER, AN ISOLATION RELAY MUST BE INSTALLED. (FIELD SUPPLIED - USE PILOT DUTY RELAY ('RC'), SUCH AS RLY0975.) SEE ALT. CONNECTION.
- 4.) IF CURRENT EXCEEDS THERMOSTAT CURRENT RATING, USE ISOLATION RELAYS ('RI') AS SHOWN. (DO NOT CONNECT W TO W) ISOLATION RELAY NOT NEEDED IF THE THERMOSTAT CONTACTS ARE RATED AT 1.0A. OR ABOVE.
- 5.) CONNECTION MAY BE REQUIRED FOR ELECTRONIC THERMOSTATS.

----- ALTERNATE WIRING CONFIGURATION SEE NOTE 4.

From Dwg. 21B341423 Rev. 1

TDD1 OUTLINE DRAWING

(ALL DIMENSIONS ARE IN INCHES)

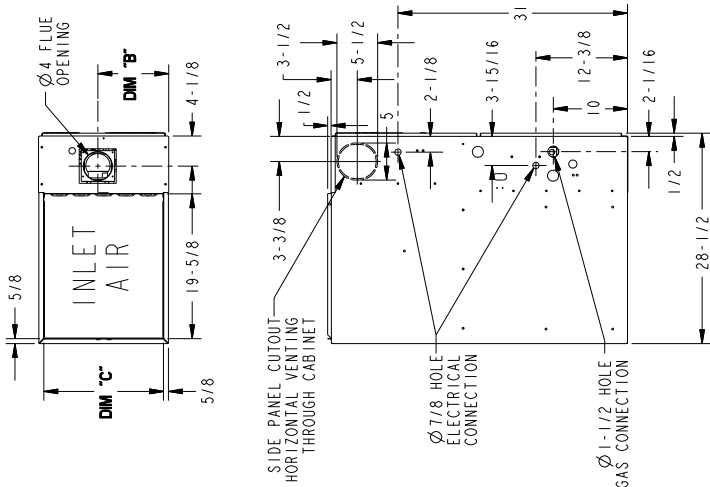

MINIMUM CLEARANCE TO COMBUSTIBLE MATERIALS

DOWNFLOW CABINET

SIDES 3" IN. W/SINGLE WALL VENT - 0 IN. W/TYPE B-I VENT
 BACK 1 IN. W/SINGLE WALL VENT - 1 IN. W/TYPE B-I VENT
 FRONT 6 IN. W/SINGLE WALL VENT - 1 IN. W/TYPE B-I VENT

* RIGHT SIDE ONLY FOR 14.5" CABINETS.
 0 IN. TO LEFT SIDE, 0 IN. FOR REMAINING
 CABINET SIZES (17.5", 21.0", 24.5").

HORIZONTAL CABINET FLUE DISCHARGE (LEFT)

TOP 3" IN. W/SINGLE WALL VENT - 2 IN. W/TYPE B-I VENT
 FRONT 6 IN. W/SINGLE WALL VENT - 1 IN. W/TYPE B-I VENT
 BACK 1 IN. W/SINGLE WALL VENT - 1 IN. W/TYPE B-I VENT
 * TOP ONLY FOR 14.5" CABINETS.
 2 IN. FOR REMAINING CABINET SIZES (17.5", 21.0", 24.5").

HORIZONTAL CABINET FLUE DISCHARGE (RIGHT)

TOP 3" IN. W/SINGLE WALL VENT - 1 IN. W/TYPE B-I VENT
 FRONT 6 IN. W/SINGLE WALL VENT - 3 IN. SIDES 1 IN.
 BACK 3 IN. SIDES 1 IN.
 * FOR INSTALLATION ON COMBUSTIBLE FLOORING ONLY
 WHEN B-I VENT CONNECTOR IS USED.

HORIZONTAL CABINET FLUE DISCHARGE (LEFT)

TOP 3" IN. W/SINGLE WALL VENT - 1 IN. W/TYPE B-I VENT
 FRONT 6 IN. W/SINGLE WALL VENT - 1 IN. W/TYPE B-I VENT
 BACK 1 IN. W/SINGLE WALL VENT - 1 IN. W/TYPE B-I VENT
 * TOP ONLY FOR 14.5" CABINETS.
 1 IN. FOR REMAINING CABINET SIZES (17.5", 21.0", 24.5").

HORIZONTAL CABINET FLUE DISCHARGE (RIGHT)

TOP 3" IN. W/SINGLE WALL VENT - 1 IN. W/TYPE B-I VENT
 FRONT 6 IN. W/SINGLE WALL VENT - 1 IN. W/TYPE B-I VENT
 BACK 0 IN. W/SINGLE WALL VENT - 1 IN. W/TYPE B-I VENT
 SIDES 0 IN.

MODEL	DIM "A"	DIM "B"	DIM "C"	DIM "D"
*DD1A040A9241A	14-1/2"	9-5/8"	13-1/4"	13"
*DD1A060A9241A				
*DD1A060A9361A				
*DD1B060A9361A	17-1/2"	9-5/8"	16-1/4"	16"
*DD1B080A9361A				
*DD1B080A9451A				
*DD1B100A9451A				
*DD1C100A9481A	21"	13-1/16"	19-3/4"	19-1/2"
*DD1C100A9541A				
*DD1C120A9541A				
*DD1D120A9601A	24-1/2"	15-5/16"	23-1/4"	23"
*DD1D140A9601A				

* PREFIX LETTER MAY BE "A" OR "T"

From Dwg. 21C341700 Rev. 0



Literature Order Number	22-1671-10
File Number	22-1671-10
Supersedes	22-1671-09
Date	06/10

Since The Trane Company has a policy of continuous product and product data improvement, it reserves the right to change design and specifications without notice.