

**58VMR  
MULTIPOISE OIL FURNACE  
INPUT RATES: 70,000 thru 154,000 BTUH  
SERIES 110**



## Product Data



A06625

### THE LATEST IN OIL FURNACE TECHNOLOGY

The model 58VMR combines variable-speed high efficiency and quiet operation with the latest oil heating technology. The 58VMR is available in 2 sizes. Each size can be fired at 3 different rates by a simple nozzle change. Unit 58VMR105 covers input ranges from 70,000 to 105,000 Btuh. Unit 58VMR120 covers input ranges from 119,000 to 154,000 Btuh. The furnace design is a multipoise style for upflow, downflow, and horizontal applications.

The components of the 58VMR are the finest in the industry. The unit uses a Riello oil burner with an electronic air damper.

The 58VMR is a standard part of a quality-built home. This energy efficient furnace will provide years of quality service to home builders and homeowners alike.

As with other Carrier furnaces, this model is designed to work as part of a total home comfort system which includes elements for cooling, air cleaning, humidification, ventilation, and zoning.

This unit is not approved for use in mobile home installations.

### 58VMR FEATURES/BENEFITS

#### Riello Oil Burner

- High quality Riello oil burner allows safe and efficient combustion of oil.

#### Casing

- Made of 20 gauge powder painted steel for years of durability and attractiveness.
- Cabinet features a reversible door, ensuring ease of service access even in downflow applications.

#### Insulation and Soundproofing

- Unique silencer baffle along with insulated walls and rubber blower mounts efficiently captures most combustion noise and vibrations and makes this unit one of the quietest on the market.

#### Combustion Products Venting

- Top or side flue outlets.
- Unit may be vented using Type L vent material and a factory-built metal or masonry chimney.
- Unit may also be sidewall vented with an approved power venter.

#### Variable Speed Blower

- Variable speed blower for precise airflow selection of heating or cooling operation.

#### Electronic Fan Control

- Electronic fan control board provides reliable operation and easy connection of thermostat and accessory wiring.

#### Combustion Chamber/Heat Exchanger

- Composed mainly of stainless and aluminized steel, the unique combination combustion chamber/heat exchanger resists corrosion, overheating, and deterioration.
- Heat transfer properties make it energy efficient.
- All seams are tightly welded for leak-free operation.

#### Certifications

- 58VMR unit is CSA certified.
- The efficiency is AHRI efficiency rating certified.

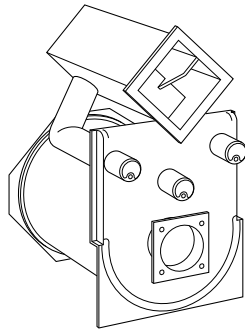

A97246

COMBUSTION CHAMBER/  
HEAT EXCHANGER

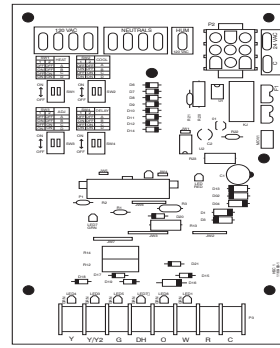

NOTES:  
1. The Green LED to the right of P-1 will illuminate whenever the first switch is open.  
2. The Green LED above the switch of P-1 will illuminate whenever the second switch is operating.  
3. The Green LED above Y, Y1/2, G, G1, and W will illuminate whenever there is a 24V AC input to the terminal.  
4. The Green LED above R will illuminate whenever there is a 24VAC input applied.

A96370

CONTROL CENTER

## MODEL NUMBER NOMENCLATURE

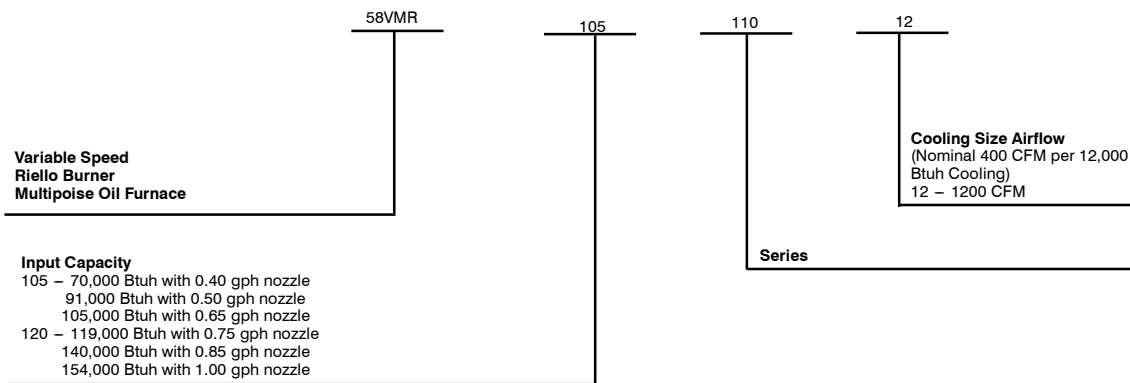

Use of the AHRI Certified TM Mark indicates a manufacturer's participation in the program. For verification of certification for individual products, go to [www.ahridirectory.org](http://www.ahridirectory.org).

**Always Ask For  
FACTORY  
AUTHORIZED  
PARTS**

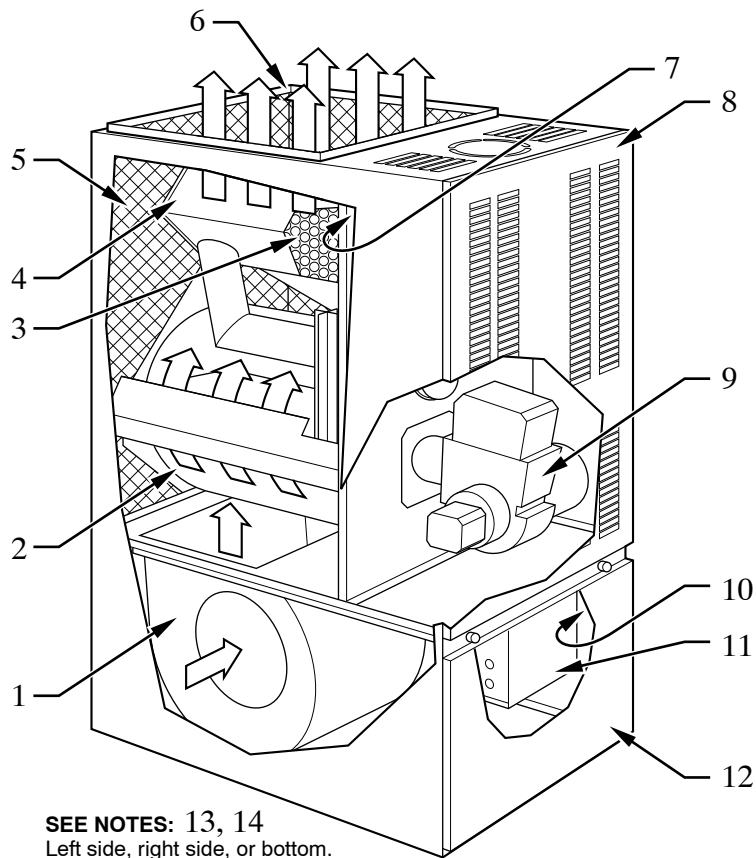

**SEE NOTES: 13, 14**  
Left side, right side, or bottom.

58VMR

A97244

1. Variable speed blower circulates air across the heat exchanger to transfer heat into the home
2. Stainless steel combustion chamber/primary heat exchanger
3. Unique silencer system reduces combustion noise
4. Heat exchanger designed and shaped to efficiently transfer heat from furnace into the home
5. Fully insulated internal walls to minimize heat loss
6. Supply-air plenum
7. High limit control to prevent overtemperature operation
8. Reversible access door provides easy access to burner and controls
9. High-performance oil burner
10. Adjustable electronic fan control (inside) has low voltage electrical terminal strip for easy connection of thermostat, cooling control, electronic air cleaner, and humidifier
11. Access door to blower
12. Air filter (field supplied)
13. Return-air plenum

# CLEARANCE TO COMBUSTIBLES

UNIT APPLICATION		UPFLOW (IN.)	DOWNFLOW (IN.)	HORIZONTAL (IN.)
SIDES	Furnace	0	2	2
	Supply Plenum and Warm–Air Duct Within 6 Ft of Furnace	1	2	1
BACK	Furnace	0	1	0
TOP	Furnace Casing or Plenum	2	2	2
	Horizontal Warm–Air Duct Within 6 Ft of Furnace	2	2	3
BOTTOM	Furnace	0	0*	0*
FLUE PIPE	Horizontally or Below Pipe	4	4	4
	Vertically Above Pipe	9	9	9
FRONT		8	8	24

\*For combustible floor, use approved accessory subbase

NOTE: Adequate service clearance should be provided over and above these dimensions as required.

58VMR

## PHYSICAL DATA

UNIT SIZE	105–12			120–20		
INPUT (BTUH)	70,000	91,000	105,000	119,000	140,000	154,000
HEATING CAPACITY*	57,000	74,000	85,000	99,000	115,000	127,000
NOZZLE	0.40 – 70A	0.50 – 70W	0.65 – 70W	0.75 – 70B	0.85 – 70W	1.00 – 70W
FIRING RATE (GPH)†	0.50	0.65	0.75	0.85	1.00	1.10
AFUE%	UPFLOW	82	82	81.5	83	82.5
	DOWNFLOW	82	82	81.5	83	82.5
	HORIZONTAL	82	82	82	83	82.5
OIL PUMP STAGES/PRESSURE (PSIG)	1/160	1/170	1/135	1/130	1/140	1/125
HEATING TEMP RISE °F	55–85	55–85	55–85	55–85	55–85	55–85
SHIPPING WEIGHT (LB)	230	230	230	275	275	275
BURNER MODEL (3450 RPM)	RIELLO 40–F3	RIELLO 40–F3	RIELLO 40–F3	RIELLO 40–F5	RIELLO 40–F5	RIELLO 40–F5

\* Capacity and AFUE in accordance with U.S. Government DOE test procedures

† For rating purposes only

Shaded cells are as Factory Shipped

## PERFORMANCE DATA

UNIT SIZE	105-12	120-20
VARIABLE SPEED ECM MOTOR	1/2	1
BLOWER WHEEL DIAMETER X WIDTH (In.)	10 x 10	12 x 10
FILTER SIZE (In.) – (Disposable, Field Supplied)	16 x 24 or 25 x 1	18 x 30 or 20 x 30 x 1

## ELECTRICAL DATA

UNIT SIZE	105-12	120-20
UNIT VOLTS-HERTZ – PHASE	115 – 60 – 1	115 – 60 – 1
OPERATING VOLTAGE RANGE (Min-Max)*	104 – 132	104 – 132
MAXIMUM UNIT AMPS	12.2	15.7
MINIMUM WIRE SIZE (AWG)	14	12
MAXIMUM WIRE LENGTH (Ft)†	26	26
MAXIMUM FUSE SIZE OR CKT BKR (Amps)‡	15	20
TRANSFORMER (24v)	40va	40va
EXTERNAL CONTROL POWER AVAILABLE		
Heating	40va	40va
Cooling	30va	30va
AIR CONDITIONING RELAY	Standard	Standard

\* Permissible limits of the voltage range at which the unit will operate satisfactorily

† Length is as measured one way along wire path between unit and service panel for maximum 2% voltage drop

‡ Time-delay fuse type is recommended

58VMR

# SIZE 105 AIRFLOW DATA (CFM)

58VMR

OIL HEATING MODE 24 VAC INPUT (R) ON W ONLY					
SW1 – HEAT Dip switch position	HEAT INPUT (USGPH)	AIRFLOW (CFM)			
		EXTERNAL STATIC PRESSURE			
		0.2 in/wc	0.5 in/wc	0.7 in/wc	0.9 in/wc
A (1 = OFF, 2 = OFF)* A (1 = OFF, 2 = OFF)** A (1 = OFF, 2 = OFF)***	0.75	1128	1146	1146	842
		1275	1295	1295	951
		959	974	974	716
B (1 = ON, 2 = OFF)* B (1 = ON, 2 = OFF)** B (1 = ON, 2 = OFF)***	0.65	894	951	969	823
		1010	1075	1095	930
		760	808	824	700
C (1 = OFF, 2 = ON)* C (1 = OFF, 2 = ON)** C (1 = OFF, 2 = ON)**	0.50	733	779	769	757
		858	880	869	855
		623	662	654	643
D (1 = ON, 2 = ON)	SAME VALUE AS A DIP SWITCH POSITION				

CONTINUOUS FAN 24 VAC INPUT (R) ON G ONLY					
SW2 – COOL Dip switch position	A/C SIZE (TON)	AIRFLOW (CFM)			
		EXTERNAL STATIC PRESSURE			
		0.2 in/wc	0.5 in/wc	0.7 in/wc	0.9 in/wc
A (1 = OFF, 2 = OFF)* A (1 = OFF, 2 = OFF)** A (1 = OFF, 2 = OFF)***	3.0	690	739	729	711
		759	813	802	782
		621	665	656	640
B (1 = ON, 2 = OFF)* B (1 = ON, 2 = OFF)** B (1 = ON, 2 = OFF)***	2.5	600	613	609	592
		660	674	670	651
		540	552	548	533
C (1 = OFF, 2 = ON)* C (1 = OFF, 2 = ON)** C (1 = OFF, 2 = ON)**	2.0	505	513	505	483
		556	564	556	531
		455	462	455	435
D (1 = ON, 2 = ON)*	1.5	441	434	417	410
D (1 = ON, 2 = ON)**		485	477	459	451
D (1 = ON, 2 = ON)***		397	391	375	369

COOLING OR HEAT PUMP HEATING MODE – SINGLE SPEED OR 2 – SPEED HIGH 24 VAC INPUT (R) ON Y/Y2 AND O (FOR COOLING)					
SW2 – COOL Dip switch position	A/C SIZE (TON)	AIRFLOW (CFM)			
		EXTERNAL STATIC PRESSURE			
		0.2 in/wc	0.5 in/wc	0.7 in/wc	0.9 in/wc
A (1 = OFF, 2 = OFF)* A (1 = OFF, 2 = OFF)** A (1 = OFF, 2 = OFF)***	3.0	918	973	973	827
		1010	1070	1070	910
		826	876	876	744
B (1 = ON, 2 = OFF)* B (1 = ON, 2 = OFF)** B (1 = ON, 2 = OFF)***	2.5	752	798	798	795
		827	878	878	875
		677	718	718	716
C (1 = OFF, 2 = ON)* C (1 = OFF, 2 = ON)** C (1 = OFF, 2 = ON)**	2.0	620	658	650	631
		682	724	715	694
		558	592	585	568
D (1 = ON, 2 = ON)* D (1 = ON, 2 = ON)** D (1 = ON, 2 = ON)***	1.5	509	520	506	497
		560	572	557	547
		458	468	455	447

NOTE: In cooling–dehumidification mode, with no 24VAC input to DH, the CFM is reduced 15%

# SIZE 105 AIRFLOW DATA (CFM) (CONTINUED)

COOLING OR HEAT PUMP HEATING MODE – 2 – SPEED LOW 24 VAC INPUT (R) ON Y1 AND O (FOR COOLING)					
SW2 – COOL Dip switch position	A/C SIZE (TON)	AIRFLOW (CFM)			
		EXTERNAL STATIC PRESSURE			
		0.2 in/wc	0.5 in/wc	0.7 in/wc	0.9 in/wc
A (1 = OFF, 2 = OFF)*	3.0	546	552	544	530
A (1 = OFF, 2 = OFF)**		601	607	598	583
A (1 = OFF, 2 = OFF)***		491	497	490	477
B (1 = ON, 2 = OFF)*	2.5	485	488	482	463
B (1 = ON, 2 = OFF)**		534	537	530	509
B (1 = ON, 2 = OFF)***		437	439	434	417
C (1 = OFF, 2 = ON)*	2.0	434	421	413	404
C (1 = OFF, 2 = ON)**		477	463	454	444
C (1 = OFF, 2 = ON)**		391	379	372	364
D (1 = ON, 2 = ON)*	1.5	372	370	364	339
D (1 = ON, 2 = ON)**		409	407	400	373
D (1 = ON, 2 = ON)***		335	333	328	305

NOTE: In cooling–dehumidification mode, with no 24VAC input to DH, the CFM is reduced 15%.

58VMR

DELAY PROFILE FOR OIL HEATING MODE				
SW4 – DELAY Dip switch position	HEAT INPUT (USGPH)	PreRun On – Delay CFM Level – Time†	ShortRun On – Delay CFM Level – Time‡	Off – Delay CFM Level – Time**
A (1 = OFF, 2 = OFF)	0.75	13% – 45 sec.	19% – 30 sec	38% – 3 min.
B (1 = ON, 2 = OFF)	0.65	13% – 45 sec.	19% – 60 sec	38% – 3 min.
C (1 = OFF, 2 = ON)	0.5	13% – 60 sec.	13% – 60 sec	38% – 3 min.
D (1 = ON, 2 = ON)	All	13% – 30 sec.	100% – 0 sec	100% – 2 min.

DELAY PROFILE FOR COOLING OR HEAT PUMP HEATING MODE				
No adjustment required	A/C size	PreRun On – Delay CFM – Level – Time†	ShortRun On – Delay CFM Level – Time‡	Off – Delay CFM Level – Time††
–	All	13% – 30 sec.	75% – 2.5 min.	50% – 3 min.

\* CFM with SW3 – ADJ Dip Switch A Position

\*\* CFM with SW3 – ADJ Dip Switch B Position

\*\*\* CFM with SW3 – ADJ Dip Switch C Position

† PreRun is the time with 0 CFM after the call for cooling or heating. The ShortRun come after the PreRun.

‡ ShortRun is the time before the blower starts at normal speed, with very low CFM, to minimize cool draft in the air distribution system.

†† Off – delay is the time required to cool down the coil (heating mode) with low CFM, to minimize cool draft in the air distribution system.

# SIZE 105 POWER DRAW (WATTS)

OIL HEATING MODE 24 VAC INPUT (R) ON W ONLY					
SW1 – HEAT Dip switch position	HEAT INPUT (USGPH)	POWER DRAW (WATTS)			
		EXTERNAL STATIC PRESSURE			
		0.2 in/wc	0.5 in/wc	0.7 in/wc	0.9 in/wc
A (1 = OFF, 2 = OFF)	0.75	285	395	467	371
B (1 = ON, 2 = OFF)	0.65	160	275	343	363
C (1 = OFF, 2 = ON)	0.50	109	203	258	307
D (1 = ON, 2 = ON)	SAME VALUE AS A DIP SWITCH POSITION				

\* NOTE: SW3–ADJ set in Switch position A.

CONTINUOUS FAN 24 VAC INPUT (R) ON G ONLY					
SW2 – COOL Dip switch position	A/C SIZE (TON)	POWER DRAW (WATTS)			
		EXTERNAL STATIC PRESSURE			
		0.2 in/wc	0.5 in/wc	0.7 in/wc	0.9 in/wc
A (1 = OFF, 2 = OFF)	3.0	100	189	244	291
B (1 = ON, 2 = OFF)	2.5	81	155	196	235
C (1 = OFF, 2 = ON)	2.0	63	122	159	193
D (1 = ON, 2 = ON)	1.5	55	104	130	172

\* NOTE: SW3–ADJ set in Switch position A.

COOLING OR HEAT PUMP HEATING MODE – SINGLE SPEED OR 2 – SPEED HIGH 24 VAC INPUT (R) ON Y/Y2 AND O (FOR COOLING)					
SW2 – COOL Dip switch position	A/C SIZE (TON)	POWER DRAW (WATTS)			
		EXTERNAL STATIC PRESSURE			
		0.2 in/wc	0.5 in/wc	0.7 in/wc	0.9 in/wc
A (1 = OFF, 2 = OFF)	3.0	178	290	350	373
B (1 = ON, 2 = OFF)	2.5	115	210	270	333
C (1 = OFF, 2 = ON)	2.0	86	166	208	251
D (1 = ON, 2 = ON)	1.5	64	121	160	193

\* NOTE: SW3–ADJ set in Switch position A.

COOLING OR HEAT PUMP HEATING MODE – 2 – SPEED LOW 24 VAC INPUT (R) ON Y1 AND O (FOR COOLING)					
SW2 – COOL Dip switch position	A/C SIZE (TON)	POWER DRAW (WATTS)			
		EXTERNAL STATIC PRESSURE			
		0.2 in/wc	0.5 in/wc	0.7 in/wc	0.9 in/wc
A (1 = OFF, 2 = OFF)	3.0	69	135	171	212
B (1 = ON, 2 = OFF)	2.5	57	116	153	189
C (1 = OFF, 2 = ON)	2.0	54	98	134	170
D (1 = ON, 2 = ON)	1.5	47	88	124	151

\* NOTE: SW3–ADJ set in Switch position A.

58VMR



# SIZE 120 AIRFLOW DATA (CFM)

OIL HEATING MODE 24 VAC INPUT (R) ON W ONLY					
SW1 – HEAT Dip switch position	HEAT INPUT (USGPH)	AIRFLOW (CFM)			
		EXTERNAL STATIC PRESSURE			
		0.2 in/wc	0.5 in/wc	0.7 in/wc	0.9 in/wc
A (1 = OFF, 2 = OFF)* A (1 = OFF, 2 = OFF)** A (1 = OFF, 2 = OFF)***	0.85	1417	1417	1417	1407
		1601	1601	1601	1590
		1204	1204	1204	1196
B (1 = ON, 2 = OFF)* B (1 = ON, 2 = OFF)** B (1 = ON, 2 = OFF)***	1.00	1674	1666	1658	1658
		1892	1883	1874	1874
		1423	1416	1409	1409
C (1 = OFF, 2 = ON)* C (1 = OFF, 2 = ON)** C (1 = OFF, 2 = ON)**	1.10	1826	1826	1826	1813
		2063	2063	2063	2049
		1552	1552	1552	1541
D (1 = ON, 2 = ON)		SAME VALUE AS A DIP SWITCH POSITION			

CONTINUOUS FAN 24 VAC INPUT (R) ON G ONLY					
SW2 – COOL Dip switch position	A/C SIZE (TON)	AIRFLOW (CFM)			
		EXTERNAL STATIC PRESSURE			
		0.2 in/wc	0.5 in/wc	0.7 in/wc	0.9 in/wc
A (1 = OFF, 2 = OFF)* A (1 = OFF, 2 = OFF)** A (1 = OFF, 2 = OFF)***	5.0	1243	1259	1259	1251
		1367	1385	1385	1376
		1119	1133	1133	1126
B (1 = ON, 2 = OFF)* B (1 = ON, 2 = OFF)** B (1 = ON, 2 = OFF)***	4.0	989	995	977	959
		1088	1095	1075	1055
		890	896	879	863
C (1 = OFF, 2 = ON)* C (1 = OFF, 2 = ON)** C (1 = OFF, 2 = ON)**	3.5	871	871	843	831
		958	958	927	914
		784	784	759	748
D (1 = ON, 2 = ON)* D (1 = ON, 2 = ON)** D (1 = ON, 2 = ON)***	3.0	773	741	741	705
		850	815	815	776
		696	667	667	635

COOLING OR HEAT PUMP HEATING MODE – SINGLE SPEED OR 2 – SPEED HIGH 24 VAC INPUT (R) ON Y/Y2 AND O (FOR COOLING)					
SW2 – COOL Dip switch position	A/C SIZE (TON)	AIRFLOW (CFM)			
		EXTERNAL STATIC PRESSURE			
		0.2 in/wc	0.5 in/wc	0.7 in/wc	0.9 in/wc
A (1 = OFF, 2 = OFF)* A (1 = OFF, 2 = OFF)** A (1 = OFF, 2 = OFF)***	5.0	1738	1738	1733	1725
		1912	1912	1912	1898
		1564	1564	1564	1553
B (1 = ON, 2 = OFF)* B (1 = ON, 2 = OFF)** B (1 = ON, 2 = OFF)***	4.0	1333	1352	1352	1342
		1466	1487	1487	1476
		1200	1217	1217	1208
C (1 = OFF, 2 = ON)* C (1 = OFF, 2 = ON)** C (1 = OFF, 2 = ON)**	3.5	1154	1154	1145	1118
		1269	1269	1260	1230
		1037	1039	1031	1006
D (1 = ON, 2 = ON)* D (1 = ON, 2 = ON)** D (1 = ON, 2 = ON)***	3.0	992	997	974	974
		1091	1097	1071	1071
		893	897	877	877

NOTE: In cooling–dehumidification mode, with no 24VAC input to DH, the CFM is reduced 15%.

58VMR

# SIZE 120 AIRFLOW DATA (CFM) (CONTINUED)

58VMR

COOLING OR HEAT PUMP HEATING MODE-2-SPEED LOW 24 VAC INPUT (R) ON Y1 AND O (FOR COOLING)					
SW2-COOL Dip switch position	A/C SIZE (TON)	AIRFLOW (CFM)			
		EXTERNAL STATIC PRESSURE			
		0.2 in/wc	0.5 in/wc	0.7 in/wc	0.9 in/wc
A (1 = OFF, 2 = OFF)*	5.0	900	900	881	860
A (1 = OFF, 2 = OFF)**		990	990	969	946
A (1 = OFF, 2 = OFF)***		810	810	793	774
B (1 = ON, 2 = OFF)*	4.0	749	723	717	695
B (1 = ON, 2 = OFF)**		824	795	789	765
B (1 = ON, 2 = OFF)***		674	651	645	626
C (1 = OFF, 2 = ON)*	3.5	680	643	617	599
C (1 = OFF, 2 = ON)**		748	707	679	659
C (1 = OFF, 2 = ON)**		612	579	555	539
D (1 = ON, 2 = ON)*	3.0	595	576	539	511
D (1 = ON, 2 = ON)**		655	634	593	562
D (1 = ON, 2 = ON)***		536	518	485	460

NOTE: In cooling-dehumidification mode, with no 24VAC input to DH, the CFM is reduced 15%.

DELAY PROFILE FOR OIL HEATING MODE				
SW4-DELAY Dip switch position	HEAT INPUT (USGPH)	PreRun On-Delay CFM Level - Time†	ShortRun On-Delay CFM Level - Time‡	Off-Delay CFM Level - Time**
A (1 = OFF, 2 = OFF)	0.85	13% - 45 sec.	44% - 30 sec.	38% - 3 min.
B (1 = ON, 2 = OFF)	1.00	13% - 30 sec.	44% - 30 sec.	38% - 3 min.
C (1 = OFF, 2 = ON)	1.10	13% - 30 sec.	50% - 30 sec.	38% - 3 min.
D (1 = ON, 2 = ON)	All	13% - 30 sec.	100% - 0 sec.	100% - 2 min.

DELAY PROFILE FOR COOLING OR HEAT PUMP HEATING MODE				
No adjustment required	A/C size	PreRun On-Delay CFM-Level - Time†	ShortRun On-Delay CFM Level - Time‡	Off-Delay CFM Level - Time††
-	All	13% - 30 sec.	75% - 2.5 min.	50% - 3 min.

\* CFM with SW3-ADJ Dip Switch A Position.

\*\*CFM with SW3-ADJ Dip Switch B Position.

\*\*\*CFM with SW3-ADJ Dip Switch C Position.

† PreRun is the time with 0 CFM after the call for cooling or heating. The ShortRun come after the PreRun.

‡ ShortRun is the time before the blower starts at normal speed, with very low CFM, to minimize cool draft in the air distribution system.

†† Off-Delay is the time required to cool down the coil (heating mode), with low CFM, to minimize cool draft in the air distribution system.

# SIZE 120 POWER DRAW (WATTS)

OIL HEATING MODE 24 VAC INPUT (R) ON W ONLY					
SW1 – HEAT Dip switch position	HEAT INPUT (USGPH)	POWER DRAW (WATTS)			
		EXTERNAL STATIC PRESSURE			
		0.2 in/wc	0.5 in/wc	0.7 in/wc	0.9 in/wc
A (1 = OFF, 2 = OFF)	0.85	356	474	565	636
B (1 = ON, 2 = OFF)	1.00	557	683	786	883
C (1 = OFF, 2 = ON)	1.10	710	870	983	1074
D (1 = ON, 2 = ON)	SAME VALUE AS A DIP SWITCH POSITION				

\* NOTE: SW3 – ADJ set in Switch position A.

CONTINUOUS FAN 24 VAC INPUT (R) ON G ONLY					
SW2 – COOL Dip switch position	A/C SIZE (TON)	POWER DRAW (WATTS)			
		EXTERNAL STATIC PRESSURE			
		0.2 in/wc	0.5 in/wc	0.7 in/wc	0.9 in/wc
A (1 = OFF, 2 = OFF)	5.0	264	382	463	532
B (1 = ON, 2 = OFF)	4.0	158	258	313	366
C (1 = OFF, 2 = ON)	3.5	125	208	249	305
D (1 = ON, 2 = ON)	3.0	105	165	218	258

\* NOTE: SW3 – ADJ set in Switch position A.

COOLING OR HEAT PUMP HEATING MODE – SINGLE SPEED OR 2 – SPEED HIGH 24 VAC INPUT (R) ON Y/Y2 AND O (FOR COOLING)					
SW2 – COOL Dip switch position	A/C SIZE (TON)	POWER DRAW (WATTS)			
		EXTERNAL STATIC PRESSURE			
		0.2 in/wc	0.5 in/wc	0.7 in/wc	0.9 in/wc
A (1 = OFF, 2 = OFF)	5.0	611	750	837	945
B (1 = ON, 2 = OFF)	4.0	312	441	527	596
C (1 = OFF, 2 = ON)	3.5	223	322	397	449
D (1 = ON, 2 = ON)	3.0	168	256	309	372

\* NOTE: SW3 – ADJ set in Switch position A.

COOLING OR HEAT PUMP HEATING MODE – 2 – SPEED LOW 24 VAC INPUT (R) ON Y1 AND O (FOR COOLING)					
SW2 – COOL Dip switch position	A/C SIZE (TON)	POWER DRAW (WATTS)			
		EXTERNAL STATIC PRESSURE			
		0.2 in/wc	0.5 in/wc	0.7 in/wc	0.9 in/wc
A (1 = OFF, 2 = OFF)	5.0	133	223	268	320
B (1 = ON, 2 = OFF)	4.0	98	162	209	252
C (1 = OFF, 2 = ON)	3.5	89	142	184	220
D (1 = ON, 2 = ON)	3.0	73	129	165	194

\* NOTE: SW3 – ADJ set in Switch position A.

58VMR

# DIMENSIONS

58VMR

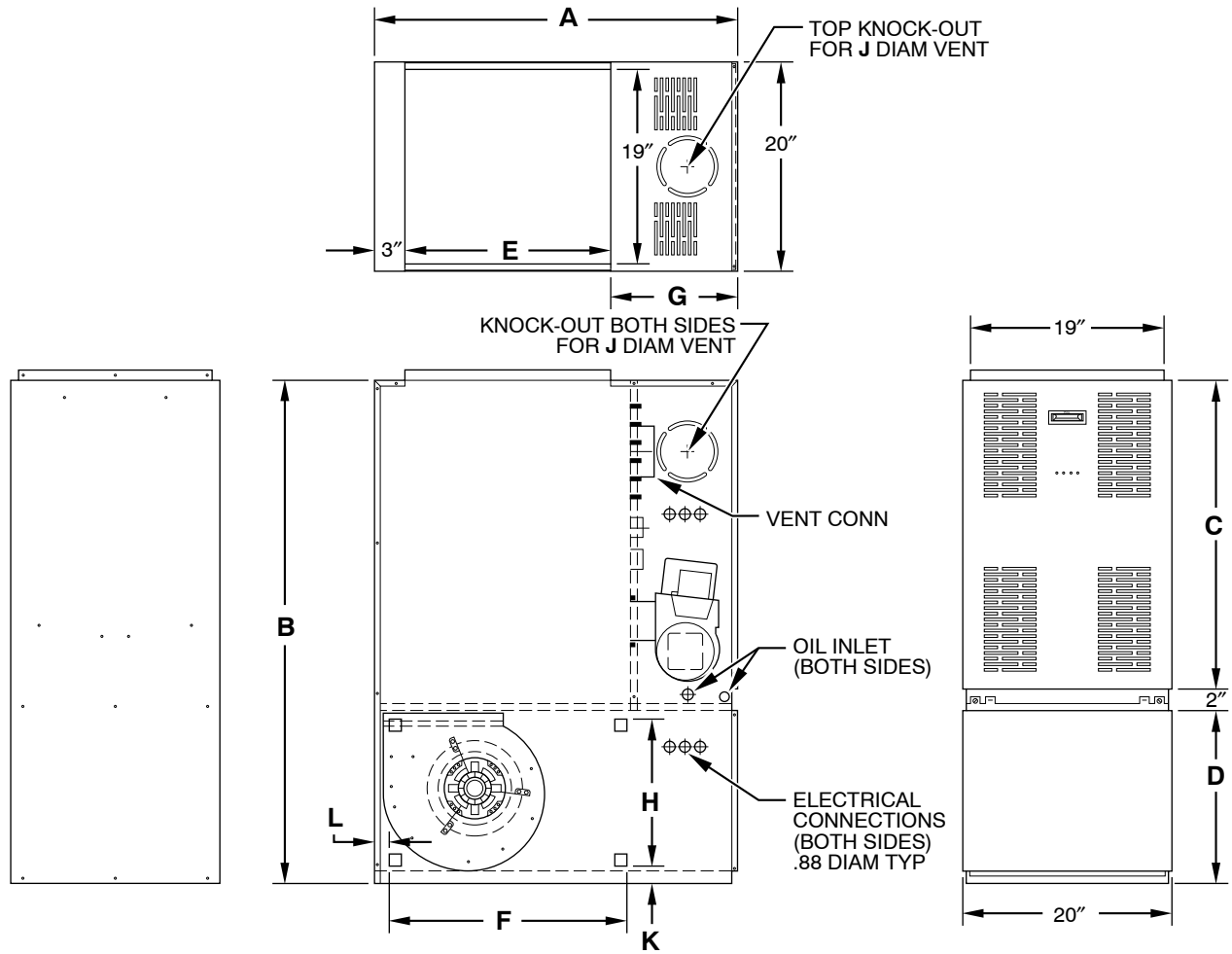

A98037

DIMENSIONS (IN.)

UNIT SIZE	A	B	C	D	E	F	G	H	J	K	L
105-12	35	48-3/4	31-1/4	16-5/8	20	22	12	14	5	1-1/2	1-3/4
120-20	39-1/2	53	33-1/4	18-3/4	24	28	12-19/32	16	6	1-5/8	1-1/2

# ACCESSORIES

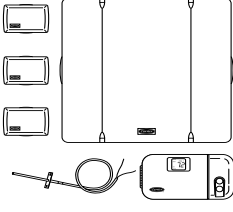

**CONTROLS:  
THERMOSTATS  
AND ZONING**

A97432

Available in programmable and non-programmable models, Carrier thermostats maintain a constant, comfortable temperature level in the home. For the ultimate in home comfort, Carrier's 2, 4, and 8-zone systems allow temperature control of individual "zones" of the home. This is accomplished through a series of electronic dampers and remote room sensors. The 4-zone system is shown.

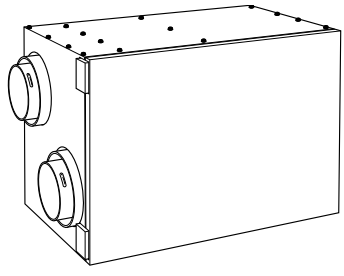

**ENERGY/HEAT  
RECOVERY  
VENTILATOR**

A94336

Carrier's energy or heat recovery ventilators exhaust stale indoor air and provide fresh outdoor air to the home while minimizing heat loss and humidity level. Especially useful for today's tighter constructed houses. Energy recovery ventilator is shown.

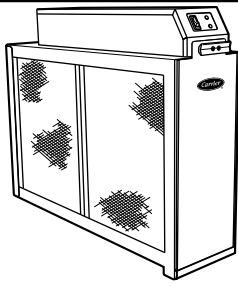

**ELECTRONIC OR  
MECHANICAL AIR  
CLEANER**

A97380

Cleans the air of smoke, dirt, and many pollens commonly found. Saves decorating and cleaning expenses by keeping carpets, furniture, and drapes cleaner. Electronic air cleaner is shown.

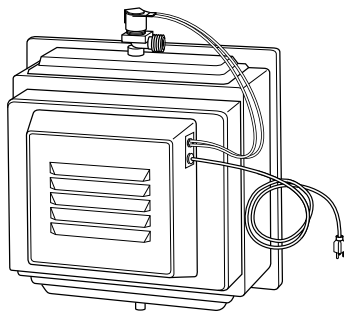

**HUMIDIFIER**

A91365

By adding moisture to winter-dry air, Carrier humidifier can often improve comfort and keeps woodwork, wallpaper, and paint in better condition. Moisturizing household air also helps to retain normal body heat and provides comfort at lower temperatures.

FURNACE ACCESSORIES	
KLASB0601DET	Downflow Subbase Kit – Required for combustible floors
KLASB0701DET	Horizontal Subbase Kit – Required for combustible floors
KLAV0101DET	Blocked Vent Shutoff Kit
KLADC0101DET	Downflow Conversion/Vent Guard – Required for downflow operation, Model 105–12
KLADC0201DET	Downflow Conversion/Vent Guard – Required for downflow operation, Model 120–20
PROGRAMMABLE THERMOSTAT SELECTION	
T6–PRH01–A	Thermostat, Auto changeover 7–Day Programmable, °F/°C, 3–Stage Heat/2–Stage Cool, Relative Humidity
T2–PAC01	Thermostat, Auto Changeover, 5–2–Day Programmable, °F/°C, 1–Stage Heat/1–Stage Cool
T2–PHP01	Thermostat, Auto Changeover, 5–2–Day Programmable, °F/°C, 2–Stage Heat/1–Stage Cool
NON–PROGRAMMABLE THERMOSTAT SELECTION	
T6–NRH01–A	Thermostat, Auto Changeover, Non–Programmable, °F/°C, 3–Stage Heat/2–Stage Cool, Relative Humidity
T2–NAC01	Thermostat, Auto Changeover, Non–Programmable, °F/°C, 1–Stage Heat/1–Stage Cool
T2–NHP01	Thermostat, Auto Changeover, Non–Programmable, °F/°C, 2–Stage Heat/1–Stage Cool
ZONING CONTROL SELECTION	
ZONECC2KIT01–B	Comfort Zone II–B – 2 Zone Kit/Temperature and Humidity Control
ZONECC4KIT01–B	Comfort Zone II–B – 4 Zone Kit/Temperature and Humidity Control
ZONECC8KIT01–B	Comfort Zone II–B – 8 Zone Kit/Temperature and Humidity Control
HEALTHY HOME SOLUTIONS	
HUMCCSBP2312	Humidifier – 12 g./day, 24V Standard, Small Bypass
HUMCASBP2312	Humidifier – 12 g./day, 24V Automatic, Small Bypass
HUMCCLBP2317	Humidifier – 17 g./day, 24V Standard, Large Bypass
HUMCALBP2317	Humidifier – 17 g./day, 24V Automatic, Large Bypass
HUMCCLFP1318	Humidifier – 18 g./day, 24V Standard, Fan Powered
HUMCALFP1318	Humidifier – 18 g./day, 24V Automatic, Fan Powered
HRVCCSHA1100	Heat Recovery Ventilator – Small Horizontal Unit, 100 CFM
HRVCCSVA1100	Heat Recovery Ventilator – Small Vertical Unit, 100 CFM
HRVCCLHA1150	Heat Recovery Ventilator – Large Horizontal Unit, 150 CFM
HRVCCLHA1250	Heat Recovery Ventilator – Large Horizontal Unit, 250 CFM
HRVCCSVU1150	Heat Recovery Ventilator – Small Vertical Unit, 150 CFM
HRVCCSVU1200	Heat Recovery Ventilator – Small Vertical Unit, 200 CFM
HRVCCLVU1150	Heat Recovery Ventilator – Large Vertical Unit, 150 CFM

## ACCESSORIES (CONTINUED)

HRVCLVU1200	Heat Recovery Ventilator – Large Vertical Unit, 200 CFM
HRVCLVU1330	Heat Recovery Ventilator – Large Vertical Unit, 330 CFM
ERVCCSHA1100	Energy Recovery Ventilator – Small Horizontal Unit, 100 CFM
ERVCCSVA1100	Energy Recovery Ventilator – Small Vertical Unit, 100 CFM
ERVCLHU1150	Energy Recovery Ventilator – Large Horizontal Unit, 150 CFM
ERVCLHU1200	Energy Recovery Ventilator – Large Horizontal Unit, 200 CFM
EZXCABCC1016	Media Filter Cabinet – 1600 CFM (Replacement Filter: EXPXXFIL0016)
EZXCABCC1020	Media Filter Cabinet – 2000 CFM (Replacement Filter: EXPXXFIL0020)

## TYPICAL INSTALLATION

58VMR

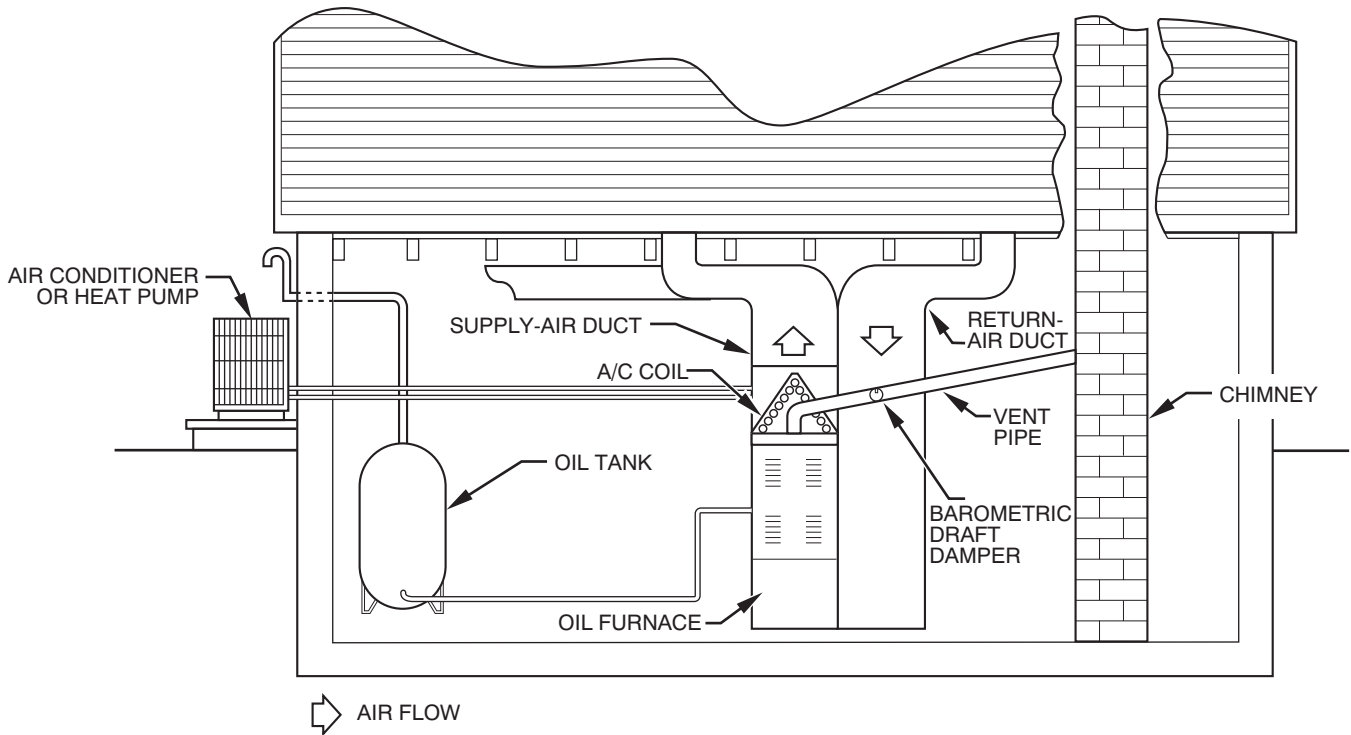

A98026