

**58CMR  
MULTIPOISE OIL FURNACE  
INPUT RATES: 70,000 thru 154,000 BTUH  
SERIES 120**



## Product Data



A06625

### THE LATEST IN OIL FURNACE TECHNOLOGY

The model 58CMR combines high efficiency and quiet operation with oil heating technology. The 58CMR is available in 2 sizes. Each size can be fired at 3 different rates by a simple nozzle change. Unit 58CMR105 covers input ranges from 70,000 to 105,000 Btuh. Unit 58CMR120 covers input ranges from 119,000 to 154,000 Btuh. The furnace design is a multipoise style for upflow, downflow, and horizontal applications.

The components of the 58CMR are the finest in the industry. The unit uses a Riello oil burner with a UTEC fan timer control.

The 58CMR is a standard part of a quality-built home. This energy-efficient furnace will provide years of quality service to home builders and homeowners alike.

As with other Carrier furnaces, this model is designed to work as part of a total home comfort system which includes elements for cooling, air cleaning, humidification, ventilation, and zoning.

This unit is not approved for use in mobile home installations.

### 58CMR FEATURES/BENEFITS

#### Riello Oil Burner and UTEC Controls

- High quality Riello oil burner allows safe and efficient combustion of oil.
- UTEC fan timer board provides reliable operation and easy connection of thermostat and accessory wiring.

#### Casing

- Made of 20-gauge, powder-painted steel for years of durability and attractiveness.
- Cabinet features a reversible door, ensuring ease of service access even in downflow applications.

#### Insulation and Soundproofing

- Unique silencer baffle, insulated walls and rubber blower mounts capture most combustion noise and vibration and make this unit one of the quietest on the market.

#### Combustion Products Venting

- Top or side flue outlet.
- Unit may be vented using Type L vent material and a factory-built metal or masonry chimney.
- Unit may also be sidewall vented with an approved power venter.

#### Adjustable Blower Speed

- 4-speed blower for precise airflow selection of heating or cooling operation.

#### Constant Low-Speed Blower Switch

- Allows continual low-speed air circulation through the home to maximize comfort while maintaining efficiency.
- Air is constantly filtered and stagnant air is avoided.
- This option can be controlled by the homeowner.

#### Combustion Chamber/Heat Exchanger

- Composed mainly of stainless and aluminized steel, the unique combination combustion chamber/heat exchanger resists corrosion, overheating, and deterioration.
- Heat transfer properties make it energy efficient.
- All seams are tightly welded for leak-free operation.

#### Certifications

- 58CMR unit is CSA certified.
- The efficiency is AHRI efficiency-rating certified.

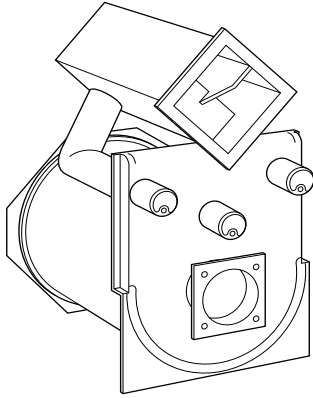

A96369

COMBUSTION CHAMBER/  
HEAT EXCHANGER

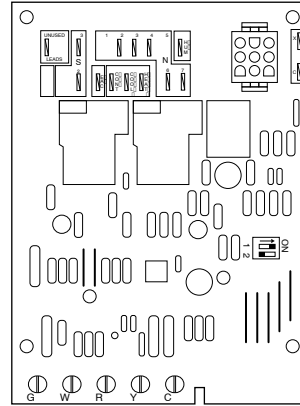

A96370

CONTROL CENTER

## MODEL NUMBER NOMENCLATURE

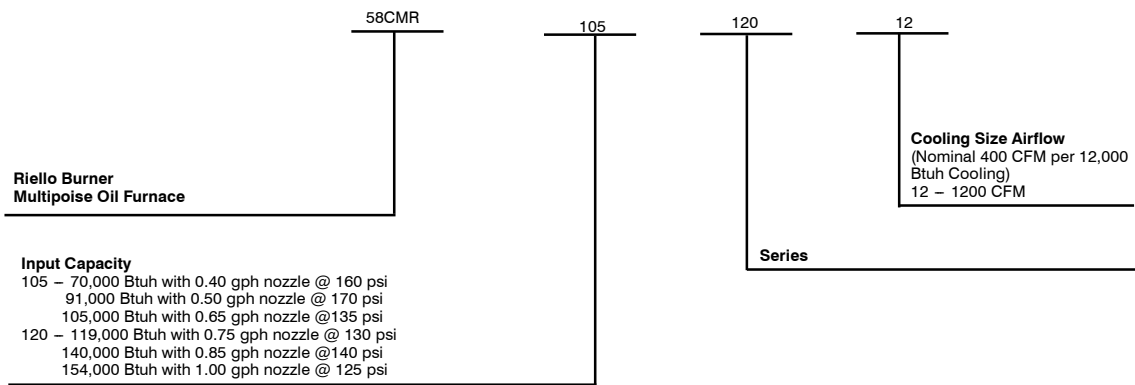

Use of the AHRI Certified TM Mark indicates a manufacturer's participation in the program. For verification of certification for individual products, go to [www.ahridirectory.org](http://www.ahridirectory.org).

**Always Ask For  
FACTORY  
AUTHORIZED  
PARTS**

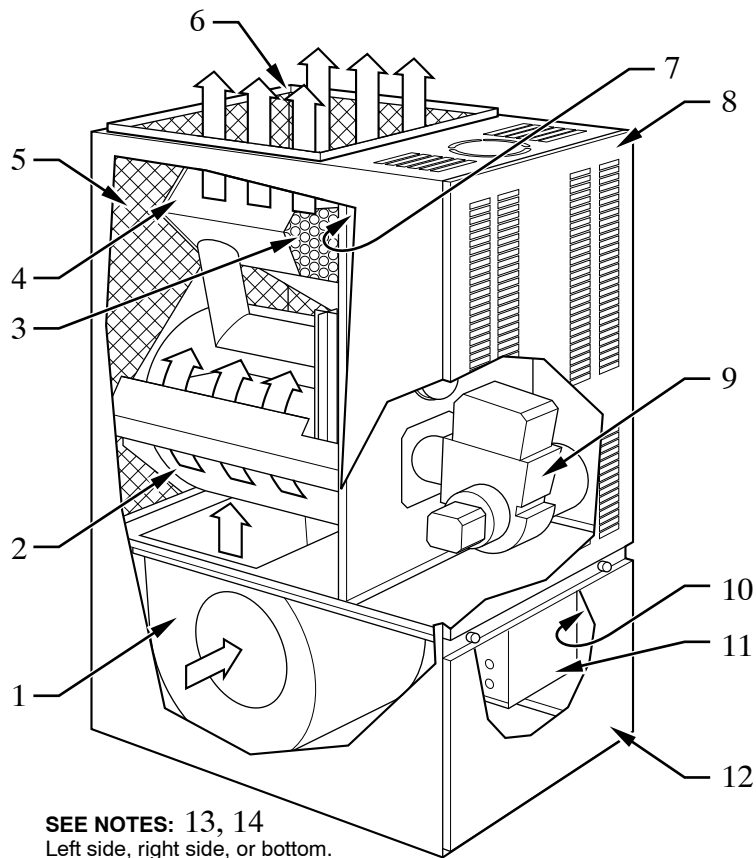

**SEE NOTES: 13, 14**  
Left side, right side, or bottom.

58CMR

A97244

1. Heavy-duty blower circulates air across the heat exchanger to transfer heat into the home.
2. Stainless steel combustion chamber/primary heat exchanger.
3. Unique silencer system reduces combustion noise.
4. Heat exchanger designed and shaped to efficiently transfer heat from furnace into the home.
5. Fully insulated internal walls to minimize heat loss and reduce sound.
6. Supply-air plenum.
7. High limit control to prevent overtemperature operation.
8. Reversible door provides easy access to burner and controls.
9. High performance oil burner.
10. Manual switch to allow user control of constant low-speed blower operation.
11. Adjustable electronic fan timer control (inside) has low voltage electrical terminal strip for easy connection of thermostat, cooling control, electronic air cleaner, and humidifier.
12. Access door to blower.
13. Air filter (field supplied).
14. Return-air plenum.

# CLEARANCE TO COMBUSTIBLES

UNIT APPLICATION		UPFLOW	DOWNFLOW	HORIZONTAL
SIDES	Furnace	0	2	2
	Supply Plenum and Warm–Air Duct Within 6 Ft of Furnace	1	2	1
BACK	Furnace	0	1	0
TOP	Furnace Casing or Plenum	2	2	2
	Horizontal Warm–Air Duct Within 6 Ft of Furnace	2	2	3
BOTTOM	Furnace	0	0*	0*
FLUE PIPE	Horizontally or Below Pipe	4	4	4
	Vertically Above Pipe	9	9	9
FRONT		8	8	24

\*For combustible floor, use approved accessory subbase.

NOTE: Adequate service clearance should be provided over and above these dimensions as required.

58CMR

## PHYSICAL DATA

UNIT SIZE	105–12			120–20		
INPUT (BTUH)	70,000	91,000	105,000	119,000	140,000	154,000
HEATING CAPACITY (BTUH)*	57,000	74,000	85,000	97,000	115,000	126,000
NOZZLE	0.40 – 70A	0.50 – 70W	0.65 – 70W	0.75 – 70B	0.85 – 70W	1.00 – 70W
FIRING RATE (GPH)†	0.50	0.65	0.75	0.85	1.00	1.10
AFUE%	UPFLOW	80.5	80.5	80.5	80.5	80.5
	DOWNFLOW	80	80	80	80	80
	HORIZONTAL	80	80	80	80	80
OIL PUMP STAGES/PRESSURE (PSIG)	1/160	1/170	1/135	1/130	1/140	1/125
HEATING TEMP RISE °F	55–85	55–85	55–85	55–85	55–85	55–85
COOLING CFM @ 0.5–IN. WC STATIC PRESSURE	1250	1250	1250	1865	1865	1865
HEATING CFM @ 0.2–IN. WC STATIC PRESSURE	840	1130	1425	1555	1890	2080
RECOMMENDED HEATING BLOWER SPEED	Med–Low	Med–High	High	Med–Low	Med–High	High
SHIPPING WEIGHT (LB)	230	230	230	275	275	275
BURNER MODEL (3450 RPM)	RIELLO 40–F3	RIELLO 40–F3	RIELLO 40–F3	RIELLO 40–F5	RIELLO 40–F5	RIELLO 40–F5

\* Capacity and AFUE in accordance with U.S. Government DOE test procedures.

† For rating purposes only.

Shaded cells are as Factory Shipped.

## PERFORMANCE DATA

UNIT SIZE	105-12	120-20
DIRECT-DRIVE MOTOR Hp (PSC)	1/3	3/4
MOTOR FULL LOAD AMPS	6.2	9.5
RPM (Nominal) – SPEEDS	1075-4	1075-4
BLOWER WHEEL DIAMETER X WIDTH (In.)	10 x 10	12 x 10
FILTER SIZE (In.) – (Disposable, Field Supplied)	16 x 24 or 25 x 1	20 x 30 x 1

## AIR DELIVERY -CFM (WITH FILTER)

UNIT SIZE	BLOWER MOTOR HP	SPEED	EXTERNAL STATIC PRESSURE (In. wc)							
			0.2	0.3	0.4	0.5	0.6	0.7	0.8	0.9
105-12	1/3 PSC	High	1425	1350	1305	1250	1170	1030	925	805
		Med-High	1130	1045	1000	950	885	820	745	670
		Med-Low	840	810	770	740	685	635	580	500
		Low	725	730	740	745	730	715	690	665
120-20	3/4 PSC	High	2080	2040	1965	1865	1700	1575	1475	1335
		Med-High	1890	1860	1770	1675	1550	1450	1330	1215
		Med-Low	1555	1475	1395	1320	1210	1135	1050	940
		Low	1220	1165	1080	1000	925	855	780	655

58CMR

## ELECTRICAL DATA

UNIT SIZE	105-12	120-20
UNIT VOLTS-HERTZ – PHASE	115 – 60 – 1	115 – 60 – 1
OPERATING VOLTAGE RANGE (Min-Max)*	104 – 132	104 – 132
MAXIMUM UNIT AMPS	12.2	15.7
MINIMUM WIRE SIZE (AWG)	14	12
MAXIMUM WIRE LENGTH (Ft)†	26	26
MAXIMUM FUSE SIZE OR CKT BKR (Amps)‡	15	20
TRANSFORMER (24v)	40va	40va
EXTERNAL CONTROL POWER AVAILABLE	Heating	40va
	Cooling	30va
AIR CONDITIONING RELAY	Standard	Standard

\* Permissible limits of the voltage range at which the unit will operate satisfactorily.

† Length is a measured one way along wire path between unit and service panel for maximum 2% voltage drop.

‡ Time-delay fuse type is recommended.

# DIMENSIONS

58CMR

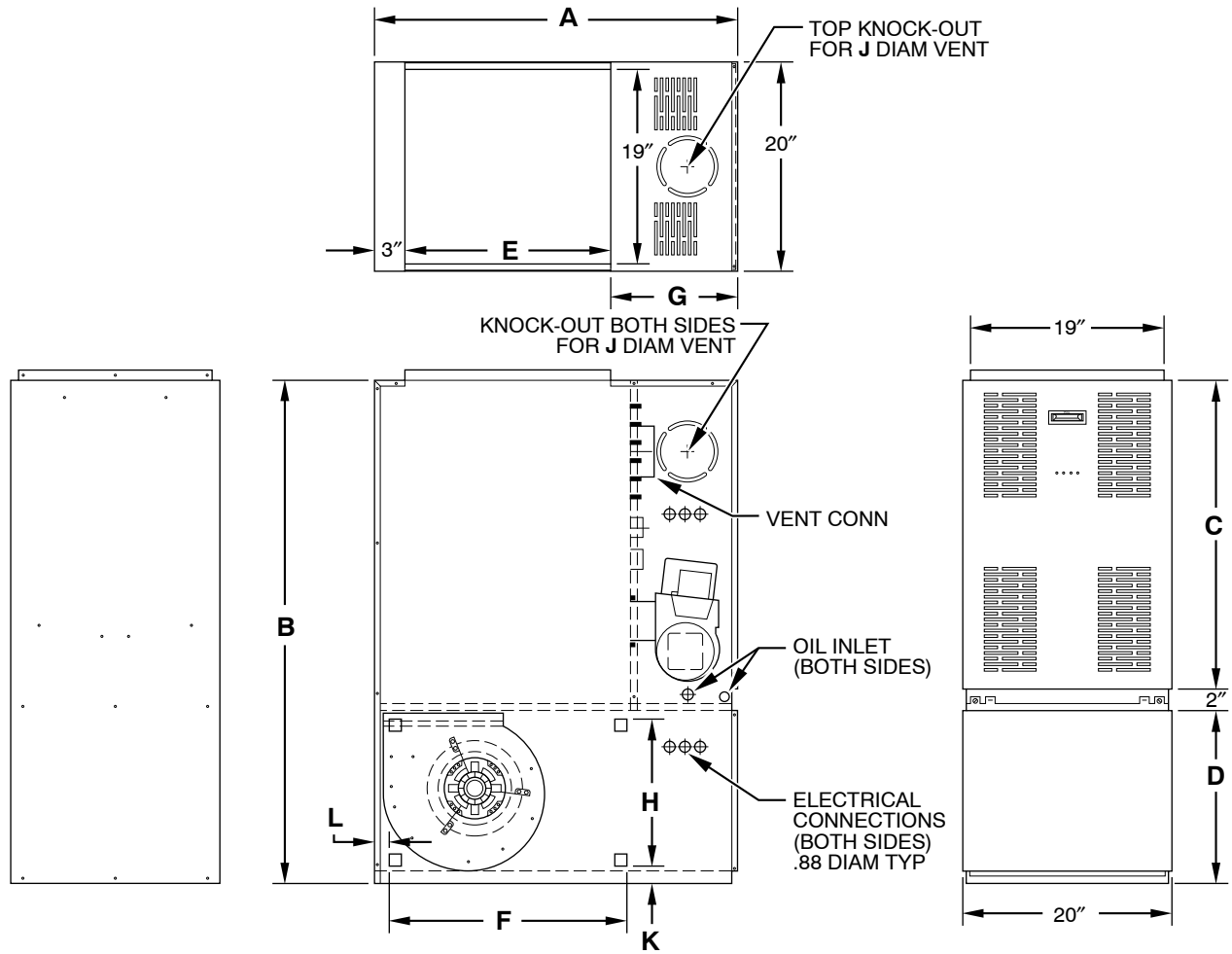

A98037

DIMENSIONS (IN.)

UNIT SIZE	A	B	C	D	E	F	G	H	J	K	L
105-12	35	48-3/4	31-1/4	16-5/8	20	22	12	14	5	1-1/2	1-3/4
120-20	39-1/2	53	33-1/4	18-3/4	24	28	12-19/32	16	6	1-5/8	1-1/2

# ACCESSORIES

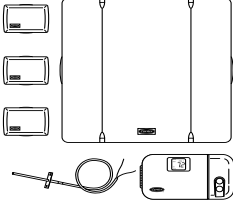

**CONTROLS:  
THERMOSTATS  
AND ZONING**

A97432

Available in programmable and non-programmable models, Carrier thermostats maintain a constant, comfortable temperature level in the home. For the ultimate in home comfort, Carrier's 2, 4, and 8-zone systems allow temperature control of individual "zones" of the home. This is accomplished through a series of electronic dampers and remote room sensors. The 4-zone system is shown.

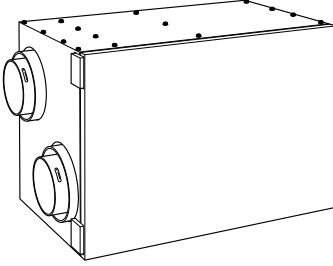

**ENERGY/HEAT  
RECOVERY  
VENTILATOR**

A94336

Carrier's energy or heat recovery ventilators exhaust stale indoor air and provide fresh outdoor air to the home while minimizing heat loss and humidity level. Especially useful for today's tighter constructed houses. Energy recovery ventilator is shown.

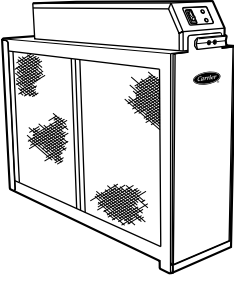

**ELECTRONIC OR  
MECHANICAL AIR  
CLEANER**

A97380

Cleans the air of smoke, dirt, and many pollens commonly found. Saves decorating and cleaning expenses by keeping carpets, furniture, and drapes cleaner. Electronic air cleaner is shown.

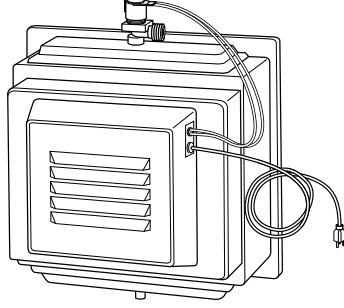

**HUMIDIFIER**

A91365

By adding moisture to winter-dry air, Carrier humidifiers can often improve comfort and keep woodwork, wallpaper, and paint in better condition. Moisturizing household air also helps to retain normal body heat and provides comfort at lower temperatures.

FURNACE ACCESSORIES	
KLASB0601DET	Downflow Subbase Kit – Required for combustible floors
KLASB0701DET	Horizontal Subbase Kit – Required for combustible floors
KLAV0101DET	Blocked Vent Shutoff Kit
KLADC0101DET	Downflow Conversion/Vent Guard – Required for downflow operation, Model 105–12
KLADC0201DET	Downflow Conversion/Vent Guard – Required for downflow operation, Model 120–20
PROGRAMMABLE THERMOSTAT SELECTION	
TP–PRH01–A	Thermostat, Auto changeover 7–Day Programmable, °F/°C, 3–Stage Heat/2–Stage Cool, Relative Humidity
TC–PAC01	Thermostat, Auto Changeover, 5–2–Day Programmable, °F/°C, 1–Stage Heat/1–Stage Cool
TC–PHP01	Thermostat, Auto Changeover, 5–2–Day Programmable, °F/°C, 2–Stage Heat/1–Stage Cool
NON–PROGRAMMABLE THERMOSTAT SELECTION	
TP–NRH01–A	Thermostat, Auto Changeover, Non–Programmable, °F/°C, 3–Stage Heat/2–Stage Cool, Relative Humidity
TC–NAC01	Thermostat, Auto Changeover, Non–Programmable, °F/°C, 1–Stage Heat/1–Stage Cool
TC–NHP01	Thermostat, Auto Changeover, Non–Programmable, °F/°C, 2–Stage Heat/1–Stage Cool
ZONING CONTROL SELECTION	
ZONECC2KIT01–B	Comfort Zone II–B – 2 Zone Kit/Temperature and Humidity Control
ZONECC4KIT01–B	Comfort Zone II–B – 4 Zone Kit/Temperature and Humidity Control
ZONECC8KIT01–B	Comfort Zone II–B – 8 Zone Kit/Temperature and Humidity Control
HEALTHY HOME SOLUTIONS	
HUMCCSBP2312	Humidifier – 12 g./day, 24V Standard, Small Bypass
HUMCASBP2312	Humidifier – 12 g./day, 24V Automatic, Small Bypass
HUMCCLBP2317	Humidifier – 17 g./day, 24V Standard, Large Bypass
HUMCALBP2317	Humidifier – 17 g./day, 24V Automatic, Large Bypass
HUMCCLFP1318	Humidifier – 18 g./day, 24V Standard, Fan Powered
HUMCALFP1318	Humidifier – 18 g./day, 24V Automatic, Fan Powered
HRVCCSHA1100	Heat Recovery Ventilator – Small Horizontal Unit, 100 CFM
HRVCCSVA1100	Heat Recovery Ventilator – Small Vertical Unit, 100 CFM
HRVCCLHA1150	Heat Recovery Ventilator – Large Horizontal Unit, 150 CFM
HRVCCLHA1250	Heat Recovery Ventilator – Large Horizontal Unit, 250 CFM
HRVCCSVU1150	Heat Recovery Ventilator – Small Vertical Unit, 150 CFM
HRVCCSVU1200	Heat Recovery Ventilator – Small Vertical Unit, 200 CFM
HRVCCLVU1150	Heat Recovery Ventilator – Large Vertical Unit, 150 CFM
HRVCCLVU1200	Heat Recovery Ventilator – Large Vertical Unit, 200 CFM

## ACCESSORIES (CONTINUED)

HRVCLVU1330	Heat Recovery Ventilator – Large Vertical Unit, 330 CFM
ERVCCSHA1100	Energy Recovery Ventilator – Small Horizontal Unit, 100 CFM
ERVCCSVA1100	Energy Recovery Ventilator – Small Vertical Unit, 100 CFM
ERVCLHU1150	Energy Recovery Ventilator – Large Horizontal Unit, 150 CFM
ERVCLHU1200	Energy Recovery Ventilator – Large Horizontal Unit, 200 CFM
EZXCABCC1016	Media Filter Cabinet – 1600 CFM (Replacement Filter: EXPXXFIL0016)
EZXCABCC1020	Media Filter Cabinet – 2000 CFM (Replacement Filter: EXPXXFIL0020)

## TYPICAL INSTALLATION

58CMR

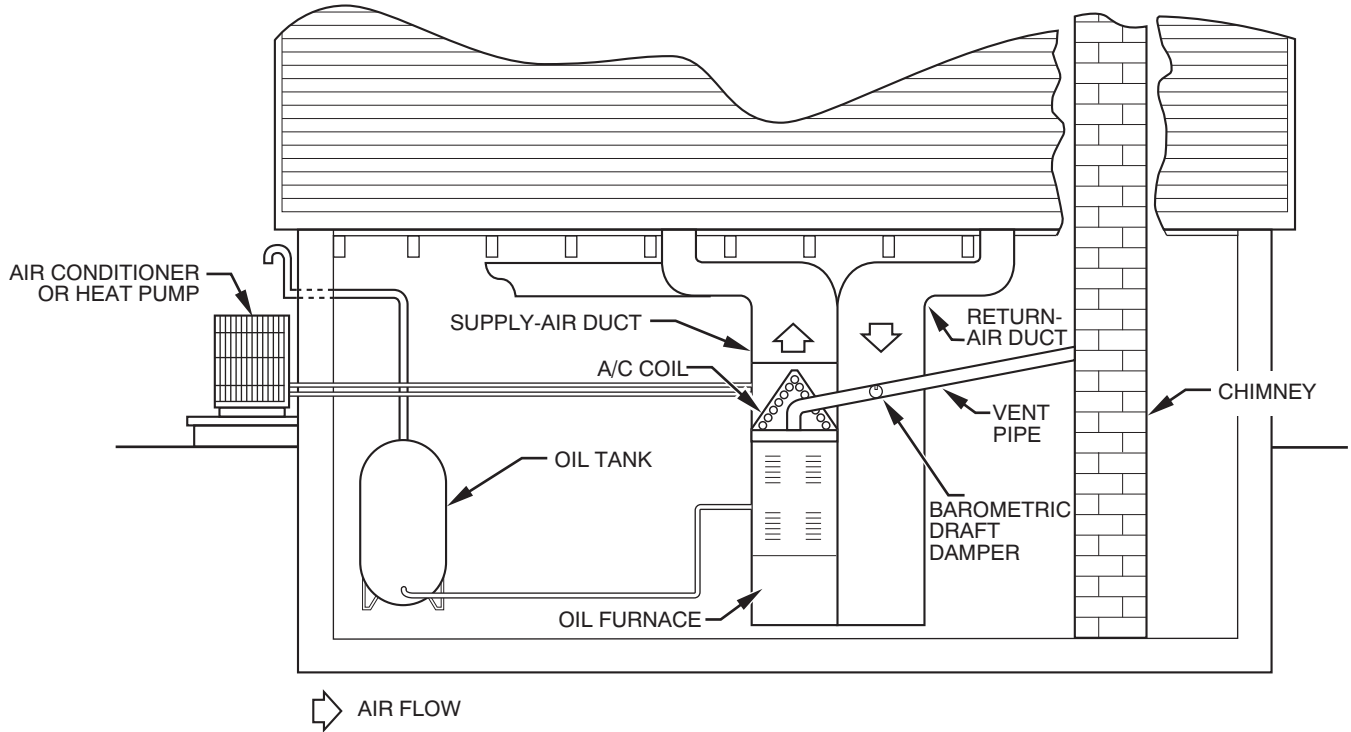

A98026